

A Textbook

Of

Science

for

Class VI

A Textbook
Of
Science
for
Class VI



**The Jammu and Kashmir Board of School Education
Srinagar/Jammu**

First Edition: 2009

Reprint: 2021

Published by

The Jammu and Kashmir Board of School Education Srinagar/Jammu

© Copy right Reserved

All rights reserved. No part of this
Publication may be reproduced, stored
in form by any means, electronic, mechanical,
Photocopying or otherwise, without first
obtaining written permission of the copyright owner.

Disclaimer

Every care has been taken by the compilers
and publishers to give correct , complete
up date information. In case there is any
omission, printing mistake, or any other
error which might have crept in inadvertently ,
neither the compiler nor publisher or any of the
distributor take any legal responsibility

Printed at: Gita Offset Printers, C-90, Okhla Industrial Area-I, New Delhi-20

FOREWORD

The Jammu and Kashmir Board of School Education initiated the process of review and revision of school curriculum to put it on what the demands of the society are. School curriculum derives its contents from social curriculum and it the class room curriculum that in its turn adds to the contours of social curriculum. Since the social curriculum is as dynamic a concept as any living organism, so there is a need to modify the contents of the school curriculum continuously to keep it updated as is required. Besides, the National Curriculum Framework-2005 also puts emphasis on dynamism of school curriculum and gives us broad guidelines to arrive at what is required to be transacted in the class rooms.

While reviewing the contents of Science Textbook for class VI enough of the contextualization has been done. It is envisaged that this contextualization will place a child firm in his context and will provide him with enough of the opportunities so that he knows his environment which will ultimately help him to know the common core of the curriculum which is same all over. Besides, NCF-2005 gives a teacher enough of freedom to sensitize a child to his locale. It is this freedom which necessitates a teacher to take a child out of class room so that a child has sufficient opportunities available, which will ignite his imagination. The igniting of imagination is sure to lead a child towards pondering over what he sees around him, natural phenomena, thereby stirring inquisitive nature and that is what the study of science is supposed to do. However, prescribing the contours of school curriculum is not one time affair instead a continuous process. What has been put in this Textbook is subject matter of debate and deliberation. I fervently appeal the stakeholders to come up with suggestions for the improvement of this Textbook which I assure, will be very valuable for us and if found genuine will be incorporated in the next edition.

I place on record my gratitude for all those who have helped us in the development of this Textbook. I also record my appreciation for Academic and Curriculum Development Research Wing. I am also thankful to NCERT, New Delhi which extended helping hand in sparing the copy rights for the use of their textual material.

*Chairman
J & K Board of School Education*

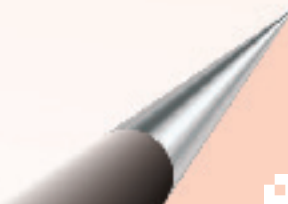

ACKNOWLEDGEMENT

The contents of this textbook were developed in various workshops conducted by CDRW and Academic Division of this Board. The Board acknowledges their help and is highly thankful to them for their contribution and suggestions. However, it has been our endeavour to bring the contents of this textbook close to the demands of the social curriculum and it remains to be seen how far we have been successful in our attempt. The Board is grateful to the following members and it is but for them that this Textbook has been possible:

1. Mr. O.N. Zaroo, Rtd. Zonal Education Officer.
2. Mr. Gh. Nabi Dar, Lecturer St. Joseph School, Baramulla
3. Mr. Altaf Hussain Ahanger, Master Government High School, Zaloora, Sopore
4. Mr. Shabir Ahmad Sirwal, Teacher, GHSS, Kishtwar
5. Ms. Neelofar Jabeen, Teacher, HSS Zainakote, Srinagar
6. Mrs Asmat Ara, Govt Middle School, Chattabal
7. Mr. Irshad Ahmed, Ex. Sr. Academic Officer (Coordinator)

The Board gratefully acknowledges the use of materials from Science Textbook of Class 6th published by National Council of Educational Research and Trainings (NCERT), New Delhi in preparing the Textbook. Suggestions for the improvement of this Text Book shall be warmly received.

Secretary
J & K Board Of School Education

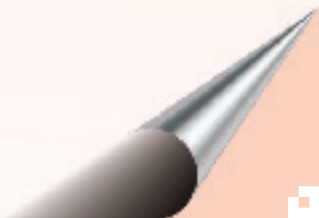

CONTENTS

Foreword:

Acknowledgement:

Chapter 1	Food Where does it Come From?	1
Chapter 2	Components of Food	8
Chapter 3	Fibre to Fabric	18
Chapter 4	Sorting Materials into Groups	27
Chapter 5	Separation of Substances	36
Chapter 6	Changes Around Us	46
Chapter 7	Getting to Know Plants	53
Chapter 8	Body Movements	69
Chapter 9	The Living organisms and their Surroundings	81
Chapter 10	Motion and Measurement of Substances	96
Chapter 11	Light, Shadows and Reflections	109
Chapter 12	Electricity and Circuits	118
Chapter 13	Fun with Magnets	127
Chapter 14	Water	138
Chapter 15	Air Around Us	147
Chapter 16	Garbage in, Garbage out	154



Chapter 1

Food — Where Does It Come From?

Keywords : Ingredients, Yolk, Albumin, Enzyme, Milch Animals, Sprout, Beehive

What did you eat at home today? Find out what your friend ate today. Did you eat the same kind of food yesterday and today? We all eat different kinds of food at different times, isn't it?

1.1 FOOD VARIETY

Activity 1

Ask your friends in the school about the items they would be eating during a day. See if you can also get this information from friends staying in different states of India. List all the items in your notebook as given in Table 1.1, for as many friends as possible.

Table 1.1 What do we eat?

Name of the Student/friend	Food items eaten in a day

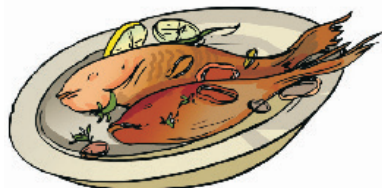

There seems to be so much variety in the food that we eat. What are these food items made of?

Think about rice cooked at home. We take raw rice and boil it in water. Just two materials or ingredients are needed to prepare a dish of boiled rice.

On the other hand, some food items are made with many ingredients. To prepare vegetable curry, we need different kinds of vegetables, salt, spices, oil and so on.



Activity 2

Choose some of the items you listed in Table 1.1 and try to find out what ingredients are used to prepare these, by discussing with your friends and elders at home. List them in Table 1.2. Some examples are given here. Add some more items to this list.

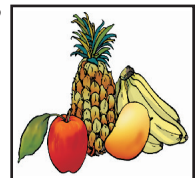

Table 1.2 Food items and their ingredients

Food Item	Ingredients
Roti/Chapati	Atta, water
Dal	Pulses, water, salt, oil/ghee, spices
Chawal	Rice, water

What do we find? Do we find some ingredients common for different food items? Discuss in class.

So, where do these ingredients come from?



1.2 FOOD MATERIALS AND SOURCES

It may be easy for us to guess the sources of some of the ingredients that we listed in Table 1.2. fruits and vegetables, for instance. Where do they come from? Plants, of course! What are the sources of rice or wheat? You may have seen paddy or wheat fields with rows and rows of plants, which give us these grains.



And then, there are food items like milk, eggs, meat, chicken, fish, prawns, beef and such others, which come from animals.

Activity 3

Let us take the food items listed earlier and try to find out where they come from — the ingredients and their sources. Some examples are shown in Table 1.3. Fill in the blanks in Table 1.3 and add more examples to this list.

Table 1.3 Ingredients used to prepare food items and their source

Food item	Ingredients	Source
Chicken curry	Chicken	Animal
	Spices	
	Oil/ghee	Plants/Animals
	Water	
Kheer	Milk	Animal
	Rice	Plant
	Sugar	

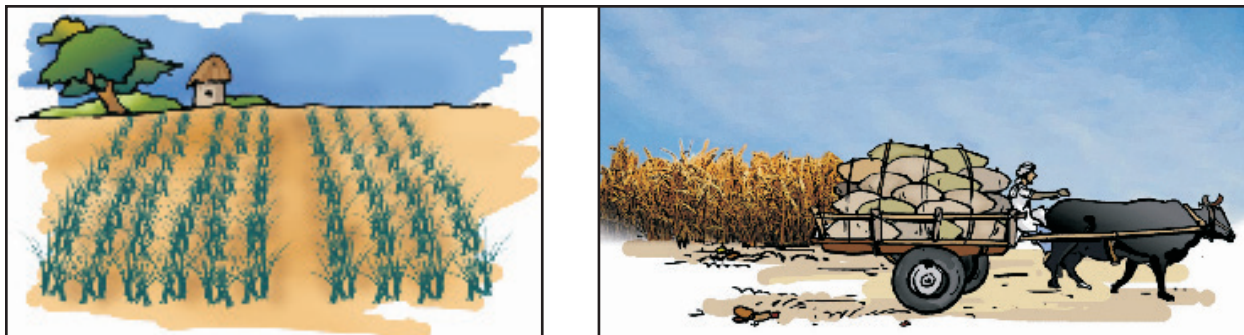

What do we conclude from Activity 3? Plants are the sources of food ingredients like grains, cereals, vegetables and fruits. Animals provide us with milk, meat products and eggs. Cows, goats and buffaloes are some common animals which give us milk. Milk and milk products like butter, cream, cheese and curd are used all over the world. Can you name some other animals which give us milk? Animals which give us milk and meat are called Milch animals e.g. goat. [More to Know]*

1.3 PLANT PARTS AND ANIMAL PRODUCTS AS FOOD

Plants are one source of our food. Which parts of a plant?

We eat many leafy vegetables. We eat fruits of some plants. Sometimes roots, sometimes stems and even flowers. Have you ever eaten pumpkin flowers dipped in rice paste and fried? Try it!

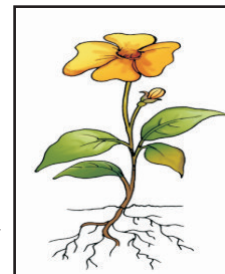

Some plants have two or more edible (eatable) parts. Seeds of mustard plants give us oil and the leaves are used as a vegetable. Can you think of the different parts of a banana plant that are used as food? Think of more examples where two or more parts of a single plant are used as food.

More to Know

- * 1. Animals which provide meat and egg are called poultry animals.
- 2. The egg has yellow (yolk) and white (albumin) portions. Yolk is rich in fats and lipids, while the albumin is rich in proteins. The egg shell is made of calcium carbonate.

Activity 4

From all the food items you have listed in Table 1.3, choose those items whose ingredients are obtained from plants and which part of a plant? Identify these and list the food items and plant parts as shown in Table 1.4.



Table 1.4 parts of Plant used as food

Food items with plant as the major source	Ingredients/source	Plant part which gives us the ingredients
1.Brinjal curry	Brinjal	Fruit
	Chilli as spice	Fruit
	Oil	Seed

Activity 5

Take some dry seeds of moong or chana. Put a small quantity of seeds in a container filled with water and leave this aside for a day. Next day, drain the water completely and leave the seeds in the vessel. Wrap them with a piece of



Sprouted Seeds

wet cloth and set aside. The following day, do you observe any changes in the seed? A small white structure may have grown out of the seeds. If so, the seeds have sprouted. If not, wash the seeds in water, drain the water and leave them aside for another day, covered with a wet cloth. The next day, see if the seeds have sprouted.

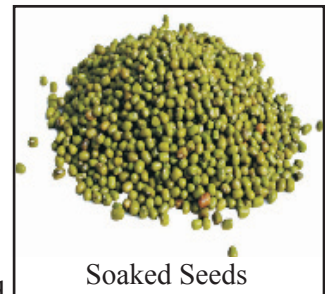

Soaked Seeds

After washing these sprouted seeds, you can eat them. They can also be boiled. Add some spices and get a tasty snack to eat of it.

Have you taste honey? Do you know where honey comes from, or how it is produced? Have you ever seen a beehive where so many bees keep buzzing about? Bees collect nectar (sweet juices) from flowers, convert it into honey and store it in their hive. Flowers and their nectar may be available only for a part of the year. So, bees store this nectar for their use all through the year in hive. When we find such a beehive, we collect the food stored by the bees as honey. Honey consists of water, sugar, minerals and enzymes. It is an antiseptic and easily digestible. For this reason honey is used in medicines.



Soaked Seeds



Sprouted Seeds



“Beehive

[The place used for the rearing of honey bees is called an apiary].



1.5 WHAT DO ANIMALS EAT?

Do you have cattle or a pet that you take care of? A dog, hen, cat, buffalo or a goat? You will then surely be aware of the food, these animals eat. What about other animals? Have you ever observed what a squirrel, pigeon, lizard or a small insect may be eating as their food?

Activity 6

Several animals are listed in Table 1.5. For some of them, the type of food they eat is also given below. Fill in the blanks in the table.



Activity 7

Have a look again at Table 1.5 and group the animals entered here as follows. Place animals which eat only plants or plant products in Group 1. These are called Herbivores. There are some animals which eat other animals only.

Table 1.5 Animals and their Food

Name of the animal	Food the animals eats
Buffalo	Grass, oilcake, hay, grains
Cat	Small animals, birds, milk
Rat	
Lion	
Tiger	
Spider	
Cow	
House Lizard	
Human beings	
Butterfly	
Crows	

Place these in Group 2. These animals are called Carnivores. Do you find some animals which eat both plants and animals? Place them in Group 3. These are called Omnivores. Prepare a table as in Table 1.6 and enter these separately in the three columns, as shown.



Table 1.6

Herbivores	Carnivores	Omnivores
Cow	Lion	Bear

We know that there are many amongst us, who do not get sufficient food. We need to find ways by which more food can be produced in the country. That will not be enough; we will need to find ways to ensure that this food is made easily available to every one.



What You have Learnt

- There is a lot of variation in the food eaten in different regions of India.
- The main sources of our food are plants and animals.
- Animals which eat only plants are called herbivores.
- Animals which eat only animals are called carnivores.
- Animals which eat both plants as well as other animals are called omnivores.



Exercises

1. Do you find that all living beings need the same kind of food?
2. Name five plants and their parts that we eat.
3. Match the items given in Column A with that in Column B

Column A

Milk, curd, paneer, ghee
 Spinach, cauliflower, carrot
 Lions and tigers
 Herbivores

Column B

eat other animals.
 eat plants and plant products.
 are vegetables.
 are all animal products.



4. Fill up the blanks with the correct words:
- (a) Tiger is a _____ because it eats only meat.
 - (b) Deer eats only plant products and so, is called _____.
 - (c) Parrot eats only _____ products.
 - (d) The _____ that we drink, which comes from cows, buffaloes and goats is an animal product.
 - (e) We get sugar from _____.
 - (f) Pulses are rich in _____ while as cereals are rich in _____.
 - (g) Animals which provide both meat and egg are called _____.
5. Why does our body need food?
6. Why man is called an omnivore?

SUGGESTED PROJECTS AND ACTIVITIES

- 1. Make a list (with pictures, when possible) of food items generally taken by people of different regions of India. Place these on a large outline map of India to display in your classroom.
- 2. Find out the names of plants that grow in water and which are eaten as food.

THINGS TO THINK ABOUT

- 1. Does everyone around you get enough food to eat? If not, why?
- 2. What are the ways we can think of to avoid wastage of food?





Components of Food

Keywords : Nutrient, Jaggery, Vitamins, Thepla, Obesity, Balanced Diet

In Chapter 1, we made lists of the food items that we eat. We also identified food items eaten in different parts of India and marked these on its map.

A meal could consist of chapati, dal and brinjal curry. Another may be rice, sambar and a vegetable preparation of ladyfinger (bhindi). Yet another meal could be fish curry and vegetables.



Activity 1

Our meals usually have at least one item made of some kind of grain. Other items could be a dal or a dish of meat or vegetable. It may also include items like curd, butter milk and pickles. Some examples of meals from different regions are given in Table 2.1. Select food items you depicted on the map in Chapter 1. Add some more meals to this list and enter these in Table 2.1.

Table 2.1 Some common meals of different regions/States

Region/State	Item of grain	Item of dal/meat	Vegetables	Others
Jammu	Wheat (roti)	Rajma and Moong	Mooli	Ghee
Kashmir	Rice	Rajma, Chicken	Knol Khol, Potato, tomato	oil
Ladakh	Rice	Rajma	Lada Khi Saag, Radish	—
Punjab	Makki (corn) roti	Rajma(Kidney beans)	Sarsoon Saag	Curd, ghee

Sometimes, we may not really have all this variety in our meals. If we are travelling, we may eat whatever is available on the way. It may not be possible for some of us, to eat such a variety of items, most of the time.

There must be some reason though, why meals usually consist of such a distribution. Do you think that our body needs different kinds of food for some special purpose?

2.1 WHAT DO DIFFERENT FOOD ITEMS CONTAIN?

We know that each dish is usually made up of one or more ingredients, which we get from plants or animals. These ingredients contain some components that are needed by our body. These components are called nutrients. The major nutrients in our food are called carbohydrates, proteins, fats, vitamins and minerals. In addition, food contains dietary fibres and water which are also needed by our body.

Do all food contain all these nutrients? With some simple methods we can test whether



cooked food or a raw ingredient contains one or more of these nutrients. The tests for presence of carbohydrates, proteins and fats are simpler to do as compared to the tests for other nutrients. Let us do these tests and record all our observations in Table 2.2.

For carrying out these tests, you will need solutions of iodine, copper sulphate and caustic soda. You will also need a few test tubes and a dropper.

Try these tests on cooked food items as well as raw materials. Table 2.2 shows you a way to record the observations from these tests. Some food items are given in this table. You can conduct the tests either with these or any other available food items. Do these tests carefully and do not try to eat or taste any chemicals.

If the required solutions are not available in readymade form, your teacher can prepare them as follows.

Let us begin by testing different food items to see if they contain carbohydrates. There are many types of carbohydrates. The main carbohydrates found in our food are in the form of starch and sugars. We can easily test if a food item contains starch.

Activity 2

Test for Starch

Take a small quantity of a food item or a raw ingredient. Put 2-3 drops of dilute iodine solution on it (Fig. 2.1). Observe if there is any change in the colour of the food item. Did it turn blue-black? A blue-black colour indicates that it contains starch.

Repeat this test with other food items to find out which of these contain starch. Enter all your observations in Table 2.2.



Fig 2.1 Testing for starch

- A dilute solution of iodine can be prepared by adding a few drops of tincture iodine to a test tube half filled with water.
- Copper sulphate solution can be prepared by dissolving 2 gram (g) of copper sulphate in 100 millilitre(ml) of water
- 10 g of caustic soda dissolved in 100 mL of water makes the required solution of caustic soda..

Test for Protein

Take a small quantity of a food item for testing. If the food you want to test is a solid, you first need to make a paste of it or powder it. Grind or mash a small quantity of the food item. Put some of this in a clean test tube, add 10 drops of water to it and shake the test tube.



Fig 2.2 Testing for protein



Now, using a dropper, add two drops of solution of copper sulphate and ten drops of solution of caustic soda to the test tube (Fig. 2.2). Shake well and let the test tube stand for a few minutes. What do you see? Did the contents of the test tube turn violet? A violet colour indicates presence of proteins in the food item.

Now, you can repeat this test on other food items.

Do You Know?
The nails on your fingers and toes and the hair on your head are pure proteins.

Table 2.2 Nutrients present in some food items

Food item	Starch (present)	Protein (present)	Fat (present)
Raw Potato	yes		
Milk		yes	
Groundnut			yes
Un cooked powdered rice			
Cooked rice			
Cooked dal			
A slice of any vegetable			
A Slice of any fruit			
Boiled egg (white portion)			

Test for Fats

Take a small quantity of a food item. Wrap it in a piece of paper and crush it. Take care that the paper does not tear. Now, straighten the paper and observe it carefully. Does it have an oily spot patch? Hold the paper against light. Are you able to see the light faintly, through this patch?

An oily patch on paper shows that the food item contains fat. The food items may sometimes contain a little water. Therefore, after you have rubbed an item on paper, let the paper dry for a while. If there were any water that may have come from food, it would dry up after some time. If no oily patch shows up after this, the food item does not contain any fat.

What do these tests show? Are fats, proteins and starch present in all the food items that you tested? Does a food item contain more than one nutrient? Do you find any food item that does not contain any of these nutrients?



We tested food items for three nutrients — carbohydrates, proteins and fats. There are also other nutrients like vitamins and minerals that are present in different food items. Why do we need all these nutrients?

2.2 WHAT DO VARIOUS NUTRIENTS DO FOR OUR BODY?

Carbohydrates mainly provide energy to our body. Fats also give us energy. In fact, fats give much more energy as compared to the same amount of carbohydrates. Foods containing fats and carbohydrates are also called ‘energy giving foods’ (Fig. 2.3 and Fig. 2.4).

Proteins are needed for the growth and repair of our body. Foods containing proteins are often called ‘body building foods’ (Fig 2.5).

Vitamins help in protecting our body against diseases. Vitamins also help in keeping our eyes, bones, teeth and gums healthy.

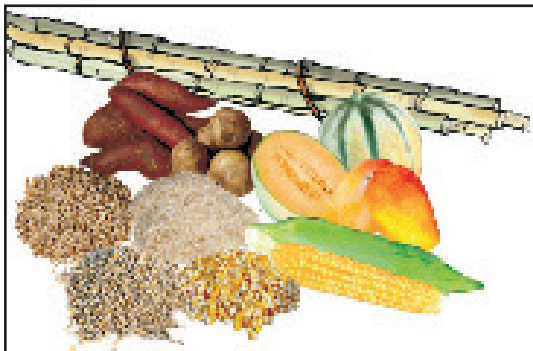
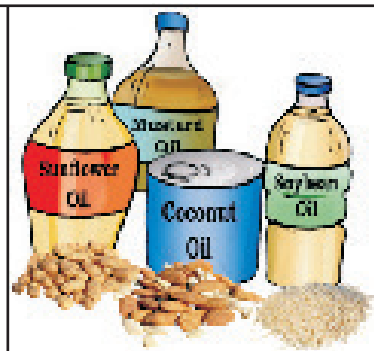

Fig 2.3 Some sources of carbohydrates



(a)



(b)

Fig2.4 Some sources of fats (a) Plant sources
(b) Animal sources



(a)

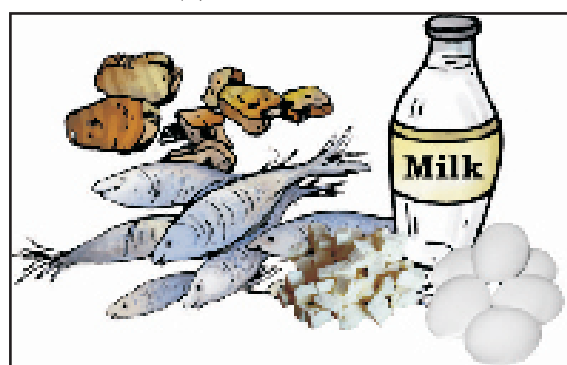

(b)

Fig 2.5 Some Sources of proteins (a) Plant sources (b) Animal sources



Vitamins are of different kinds known by different names. Some of these are Vitamin A, Vitamin C, Vitamin D, Vitamin E and K. There is also a group of vitamins called Vitamin B-complex. Our body needs all types of vitamins in small quantities. Vitamin A keeps our skin and eyes healthy. Vitamin C helps body to fight against many diseases. Vitamin D helps our body to use calcium for bones and teeth. Foods that are rich in different vitamins are shown in Fig. 2.6 to Fig. 2.9.

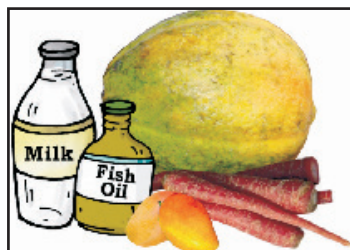

Fig 2.6 Some sources of Vitamin A



Fig 2.7 Some sources of Vitamin B



Fig 2.8 Some sources of Vitamin C

Minerals are needed by our body in small amounts. Each one is essential for proper growth of body and to maintain good health. Some sources of different minerals are shown in Fig. 2.10.

Most food items, usually, have more than one nutrient. You may have noticed this, while recording your observations in Table 2.2. However, in a given raw material, one particular nutrient may be present in much larger quantity than in others. For example, rice has more carbohydrates than other nutrients. Thus, we say that rice is a “carbohydrate rich” source of food.



Fig 2.9 Some sources of Vitamin D

Besides these nutrients, our body needs dietary fibres and water. Dietary fibres are also known as roughage. Roughage is mainly provided by plant products in our foods. Whole grains and pulses, potatoes, fresh fruits and vegetables are main sources of roughage. Roughage does not provide any nutrient to our body, but is an essential component of our food and adds to its bulk. This helps our body to get rid of undigested food.

Water helps our body to absorb nutrients from food. It also helps in throwing out some wastes from body as urine and sweat. Normally, we get most of the water that our body needs



Some sources of iodine, Iodine Source



Some sources of Phosphorus, P. Source



Some sources of Iron, Iron Source



Some sources of Calcium, Calcium Source

Fig 2.10 Sources of some minerals



from the liquids we drink — such as water, milk and tea. In addition, we add water to most cooked foods. Let's see if there is any other source which provides water to our body.

Activity 3

Take a tomato or a fruit like lemon. Cut it into small pieces. Do your hands get wet while doing so?

Carefully observe whenever vegetables and fruits are being cut, peeled, grated or meshed at your home. Do you find any fresh vegetables or fruits that do not contain some amount of water?

We see that many food materials themselves contain water. To some extent, our body needs are met by this water. Apart from this, we also add water while cooking many food items.

2.3 BALANCED DIET

The food we normally eat in a day is our diet. For growth and maintenance of good health, our diet should have all the nutrients that our body needs, in right quantities. Not too much of one and not too little of the other. The diet should also contain a good amount of roughage and water. Such a diet is called a balanced diet.

Do you think that people of all ages need the same type of diet? Do you also think that, what we need for a balanced diet would depend on the amount of physical work that we do?

Prepare a chart of whatever you eat over a period of a week. Check whether all the nutrients mentioned are present in one or the other food items being eaten within a day or so.



Pulses, groundnut, soyabean, sprouted seeds (moong and Bengal gram), fermented foods (South Indian foods such as idlis), a combination of flours (missi roti, thepla made from cereals and pulses), banana, spinach, sattu, jaggery, available vegetables and other such foods provide many nutrients. Therefore, one can eat a balanced diet without using expensive food materials.

Eating the right kind of food is not enough. It should also be cooked properly so that its nutrients are not lost. Are you aware that some nutrients get lost in the process of cooking and preparations?

If the vegetables and fruits are washed after cutting or peeling them, it may result in the loss of some vitamins. The peel of many vegetables and fruits contain vitamins and minerals. Similarly, repeated washing of rice and pulses may remove some vitamins and minerals present in them e.g. too much washing of tomato can lead to loss of vitamin C, as vitamin C is water soluble and gets dissolved easily.



We all know that cooking improves the taste of food and makes it easier to digest. At the same time, cooking also results in the loss of certain nutrients. Many useful proteins and considerable amount of minerals are lost if excess water is used during cooking and is then thrown away.

Vitamin C gets easily destroyed by heat during cooking. Would it not be sensible to include some fruits and raw vegetables in our diet?

A man thought that fats would be the best foods to eat, all the time. A katori of fat will give much more energy than a katori of carbohydrate rich food, isn't it? So, The man ate nothing but food rich in fats — fried food like samosa and poori, malai, rabdi and peda.

Do you think he was right? No, of course not! It can be very harmful for us to eat too much of fat rich foods and we may end up suffering from a condition called obesity.

More to Know

Mid- Day Meal Programme

The Mid –Day Meal programme is also called School Lunch or School Meal programme. The aim of this programme is to provide such a meal as will overcome the deficiencies in their diets at home in Children. In rural areas, many children come to school partly hungry or even with an empty stomach. MDM is useful in the proper growth and development of such children.

2.4 DEFICIENCY DISEASES

A person may be getting enough food to eat, but sometimes the food may not contain a particular nutrient. If this continues over a long period of time, the person may suffer from its deficiency. Deficiency of one or more nutrients can cause diseases or disorders in our body. Diseases that occur due to lack of nutrients over a long period are called **deficiency diseases**.

If a person does not get enough proteins in his/her food for a long time, he/she is likely to have stunted growth, swelling of face, discolouration of hair, skin diseases and diarrhoea.

If the diet is deficient in both carbohydrates and proteins for a long period of time, the growth may stop completely. Such a person becomes very lean and thin and so weak that he/she may not even be able to move or stand.

Deficiency of different vitamins and minerals may also result in certain diseases or disorders. Some of these are mentioned in Table 2.3.



Table 2.3 Some diseases/disorders caused by deficiency of vitamins and Minerals.

Vitamin/Mineral	Deficiency disease/disorder	Symptoms
Vitamin A	Loss of vision	Poor vision, loss of vision in darkness (night), sometimes complete loss of vision
Vitamin B1	Beri-beri	Weak muscles and very little energy to work
Vitamin C	Scurvy	Bleeding of gums, wound take longer time to heal
Vitamin D	Rickets	Bones become soft and bent
Calcium	Bone and tooth decay	Weak bones, tooth decay
Iodine	Goiter	Glands in the neck appear swollen, mental disability in children
Iron	Anaemia	Weakness

All deficiency diseases can be prevented by taking a balanced diet.

In this chapter, we asked ourselves the reason why widely varying food from different regions had a common distribution. This distribution, we find, ensures that our meals have a balance of the different nutrients needed by the body.

LOOK OUT: Much of the food we eat is processed food. Polished rice and wheat flour (maida) are the examples of “processed foods”.

Processing removes many of the B vitamins. Besides beri-beri is caused by lack of Vitamin B₁, we should therefore avoid foods which are processed or polished.

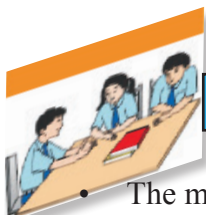

What You have Learnt

- The major nutrients in our food are carbohydrates, proteins, fats, vitamins and minerals. In addition, food also contains dietary fibres and water.
- Carbohydrates and fats mainly provide energy to our body.
- Proteins and minerals are needed for the growth and the maintenance of our body.
- Vitamins help in protecting our body against diseases.
- Balanced diet provides all the nutrients that our body needs, in right quantities, along with adequate amount of roughage and water.



- Deficiency of one or more nutrients in our food for a long time may cause certain diseases or disorders.



Exercises

1. Name the major nutrients in our food.
2. Why should we include vitamins in our diet?
3. What is the aim of Mid-Day Meal Programme?
4. Name the following:
 - a. The nutrients which mainly give energy to our body.
 - b. The nutrients that are needed for the growth and maintenance of our body.
 - c. A vitamin required for maintaining good eyesight.
 - d. A mineral that is required for keeping our bones healthy.
5. Name two foods each rich in:
 - a. Fats
 - b. Starch
 - c. Dietary fibre
 - d. Protein
6. Tick (✓) the statements that are correct.
 - a. By eating rice alone, we can fulfill nutritional requirement of our body. ()
 - b. Deficiency diseases can be prevented by eating a balanced diet. ()
 - c. Balanced diet for the body should contain a variety of food items. ()
 - d. Meat alone is sufficient to provide all nutrients to the body. ()
7. Fill in the blanks.
 - a. _____ is caused by deficiency of Vitamin D.
 - b. Deficiency of _____ causes a disease known as beri-beri.
 - c. Deficiency of Vitamin C causes a disease known as _____.
 - d. Night blindness is caused due to deficiency of _____ in our food.



- e. Proteins of animal origin are _____, _____ and _____.
- f. Roughage helps in proper functioning of the _____.
- g. Deficiency of Iodine leads to _____.

SUGGESTED PROJECTS AND ACTIVITIES

1. Prepare a diet chart to provide balanced diet to a twelve year old child. The diet chart should include food items which are not expensive and are commonly available in your area.
2. We have learnt that excess intake of fats is harmful for the body. What about other nutrients? Would it be harmful for the body to take too much of proteins or vitamins in the diet? Read about diet related problems to find answers to these questions and have a class discussion on this topic.
3. Test the food usually eaten by cattle or a pet to find out which nutrients are present in animal food. Compare results obtained from the whole class to conclude about balanced diet requirements for different animals.





Fibre to Fabric

Keywords: Fleece, Shahtoosh, Cocoon, Sericulture, Flex, Knitting

Aamir and Samir won the first prize in a Science Quiz competition held at their school. They were very excited and decided to use the prize money to buy clothes for their parents. When they saw a large variety of cloth material, they got confused (Fig. 3.1). The shopkeeper explained that some clothes or fabrics were cotton and some were synthetic. He also had woollen mufflers and shawls. There were many silk sarees as well. Aamir and Samir felt very excited. They touched and felt these different fabrics. Finally, they bought a woollen muffler and a cotton saree.

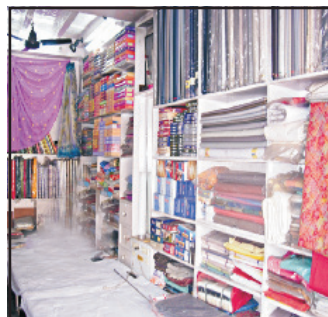

Fig 3.1 A cloth shop

After their visit to the cloth shop, Aamir and Samir began to notice various fabrics in their surroundings. They found that bed sheets, blankets, curtains, tablecloths, towels and dusters were made from different kinds of fabrics. Even their school bags and the gunny bags were made from some kind of fabric. They tried to identify these fabrics as cotton, wool, silk or synthetic. Can you also identify some fabrics?

3.1 VARIETY IN FABRICS

Activity 1

- Visit a nearby tailoring shop.
- Collect cuttings of fabrics leftover after stitching. Feel and touch each piece of fabric.
- Now, try to label some of the fabrics as cotton, silk, wool or synthetic after asking for help from the tailor.

Do you wonder what these different fabrics are made of? When you look at any fabric, it seems a continuous piece. Now, look at it closely. What do you notice (Fig. 3.2)?

Activity 2

- Select a piece of cotton fabric you labelled in Activity 1.
- Now, try to find a loose thread or **yarn** at one of the edges and pull it out (Fig. 3.3). If no loose yarns are visible, you can gently pull one out with a pin or a needle.

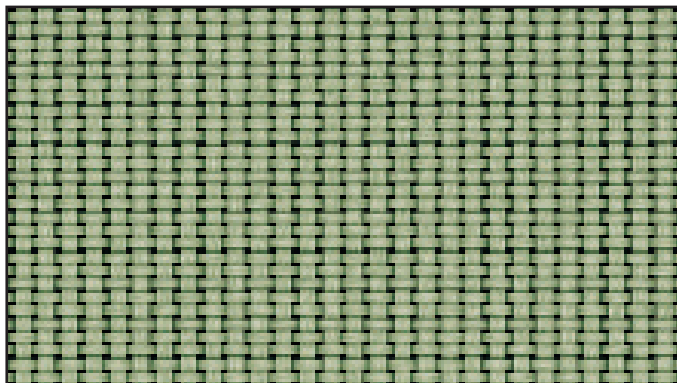

Fig 3.2 Enlarged view of a piece of Fabric



We find that a fabric is made up of yarns arranged together. What are these yarns made of?

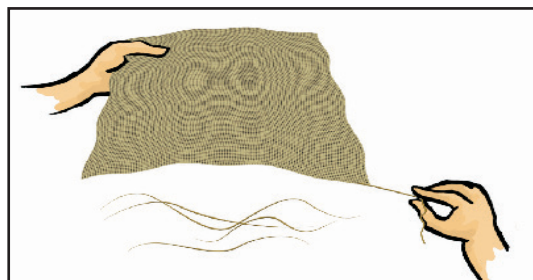

Fig 3.3 Pulling a thread from a fabric

3.2 FIBRE

Activity 3

Take out a yarn from a piece of cotton fabric. Place this piece of yarn on the table. Now, press one end of the yarn with your thumb. Scratch the other end of the yarn along its length with your nail as shown in Fig. 3.4. Do you find that at this end, the yarn splits up into thin strands? (Fig. 3.5)



Fig 3.4 Splitting the yarn



Fig 3.5 Yarn splits into thin strands

You might have observed something similar when you try to thread a needle. Many a time, the end of the thread is separated into a few thin strands. This makes it difficult to pass the thread through the eye of the needle. The thin strands of thread that we see, are made up of still thinner strands called **fibres**.

Fabrics are made up of yarns and yarns are further made up of fibres. Where do these fibres come from?

The fibres of some fabrics such as cotton, jute, silk and wool are obtained from plants and animals. These are called **natural fibres**. Cotton and jute are examples of fibres obtained from plants. Wool and silk fibres are obtained from animals. Wool is obtained from the fleece of sheep or goat. It is also obtained from the hair of rabbits, yak and camels. Silk fibre is drawn from the cocoon of silkworm.

For thousands of years natural fibres were the only ones available for making fabrics. In the last hundred years or so, fibres are also made from chemical substances, which are not obtained



from plant or animal sources. These are called **synthetic fibres**. Some examples of synthetic fibres are polyester, nylon and acrylic, Polyethene.

3.3 SOME PLANT AND ANIMAL FIBRES

Cotton

Have you ever made wicks for oil lamps? What do you use for making these wicks? This cotton wool is also used for filling mattresses, quilts or pillows.

Take some cotton wool, pull it apart and look at its edges. What do you observe? The small, thin strands that you see are made up of cotton fibres.

Where does this cotton wool come from? It is grown in the fields. Cotton plants are usually grown at places having black soil and warm climate.



Fig 3.6 Field of cotton plants



Fig 3.7 Ginning of Cotton

Can you name some states of our country where cotton is grown? The fruits of the cotton plant (**cotton bolls**) are about the size of a lemon. After maturing, the bolls burst open and the seeds covered with cotton fibres can be seen. Have you ever seen a cotton field that is ready for picking? It looks like a field covered with snow (Fig.3.6).

From these bolls, cotton is usually picked by hand. Fibres are then separated from the seeds by combing. This process is called **ginning** of cotton. Ginning was traditionally done by hand (Fig.3.7). These days, machines are also used for ginning.

Jute

Jute fibre is obtained from the stem of the jute plant (Fig 3.8). It is cultivated during the rainy season. In India, jute is mainly grown in West Bengal, Bihar and Assam. The jute plant is normally harvested when it is at flowering stage. The stems of the harvested plants are immersed in water for a few days. The stems rot and fibres are separated by hand.



Fig 3.8 A Jute plant



Fig 3.9 Making yarn from cotton

To make fabrics, all these fibres are first converted into yarns. How is it done?



Silk-Wool

Wool and silk are the most common fibres from animals viz, sheep and silkworm.

Wool, a natural fibre is obtained from the fibre/hair of sheep. It acts as a protective covering of the sheep. The quality of wool depends upon the age and the health, and climate condition of the animal. Quality of the wool depends upon the climate in which the animal lives.



Sheep



Sheep shearing



Wool



Wool Roving

- Lamb's wool comes from the body of the sheep.
- Soft wool comes from an adult sheep.
- Rough wool comes from aged and diseased sheep.
- Angora comes from angora and Kashmiri goat and angora rabbit.
- Pashmina comes from hill goat living in cold regions.
- Shahtoosh the costliest and softest wool comes from the Tibetan goat called entelope living in icy cold regions.
- Wool from Yak, the animal found in the UT of Ladakh is used for making blankets. Pashmina is obtained from the goats found in hilly regions of Jammu and Kashmir.

Processing of Wool:

It involves four steps

1. Shearing of sheep's skin
2. Grading
3. Carding
4. Spinning

Fibres obtained are twisted to make yarn. The yarn is weaved into fabric or retained for knitting; Kashmiris and Ladakhis use woollen fabric and knitted garments to keep away the cold of harsh winters.

SILK:

Silk comes from silkworm moth, a relation of butterfly. Fine thread is spun by the larva, (caterpillar)



of the silkworm. The ball of silk thread around the silkworm of the caterpillar is called cocoon which is actually a protective covering of the caterpillar. To obtain silk, the cocoon is boiled, killing the worms inside and the silk thread is obtained. The silk is produced by special glands of the caterpillar located near the mouth. The silk filament is of varied length and the filaments are twisted together to make silk thread. Silk of Kashmir is soft, smooth and lustrous. Kashmir used to be famous for silk as Kashmir silk is soft, smooth and lustrous but now China has taken the lead and is the largest silk producer in the world.



Life cycle of silkworm

Activity to perform

Seek information from Sericulture Department about Silkworm breeding and cultivating cocoons.

3.4 SPINNING COTTON YARN

You can try making cotton yarn yourself.

Activity 4

- Hold some cotton wool in one hand. Pinch some cotton between the thumb and forefinger of the other hand. Now, gently start pulling out the cotton, while continuously twisting the fibres (Fig. 3.9). Are you able to make a yarn?



Fig 3.10 A Takli

The process of making yarn from fibres is called **spinning**. In this process, fibres from a mass of cotton wool are drawn out and twisted. This brings the fibres together to form a yarn.

A simple device used for spinning is a hand spindle, also called takli (Fig. 3.10). Another hand operated device used for spinning is charkha (Fig. 3.11). Use of charkha was popularised by Mahatma Gandhi as part of the Independence movement.



Fig 3.11 Charkha.

He encouraged people to wear clothes made of homespun yarn and shun imported cloth made in the mills of Britain.

Spinning of yarn on a large scale is done with the help of spinning machines. After spinning, yarns are used for making fabrics.



3.5 YARN TO FABRIC

There are many ways by which fabrics are made from yarns. The two main processes are weaving and knitting.

Weaving

In Activity 2, you might have noticed that a fabric is made up of two sets of yarns arranged together. The process of arranging two sets of yarns together to make a fabric is called weaving. Let us try to weave some paper strips.

Activity 5

Take two sheets of paper of different colours. Cut square pieces of length and width equal to 30 cm from each sheet. Now, fold both the sheets into half. On one sheet draw lines as shown in the Fig 3.12 (a) and on the other as shown in Fig.3.12 (b). Cut both the sheets along the dotted lines and then unfold. Weave the strips one by one through the cuts in the sheet of paper as shown in Fig.3.12 (c). Fig. 3.12 (d) shows the pattern after weaving all the strips.



(a)



(b)

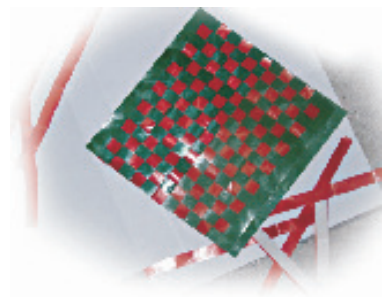

(c)

Fig 3.12 Weaving with paper strips

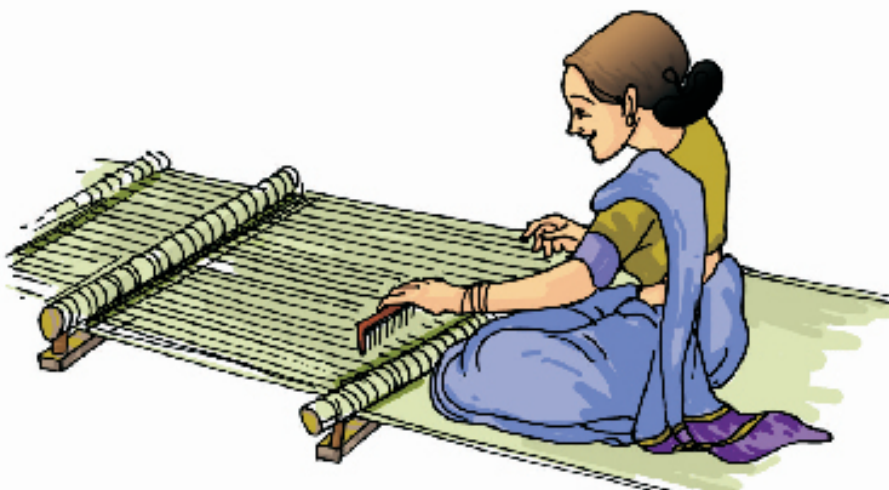

Fig 3.13 Handloom

In a similar manner, two sets of yarn are woven to make a fabric. The yarns are much thinner than our paper strips, of course! Weaving of fabric is done on looms (Fig. 3.13). The looms are either hand operated or power operated.



Knitting

Have you noticed how sweaters are knitted? In knitting, a single yarn is used to make a piece of fabric (Fig. 3.14). Have you ever pulled the yarn from a torn pair of socks? What happens? A single yarn gets pulled out continuously as the fabric gets unravelled. Socks and many other clothing items are made of knitted fabrics. Knitting is done by hand and also on machines.



Fig 3.14 Knitting

Weaving and knitting are used for making different kinds of fabric.

These fabrics are used for a variety of clothing items.

3.6 HISTORY OF CLOTHING MATERIAL

Have you ever wondered what materials people used in ancient times for clothes? It appears that in those times people used the bark and big leaves of trees or animal skins and furs to cover themselves.

After people began to settle in agricultural communities, they learnt to weave twigs and grass into mats and baskets. Vines, animal fleece or hair were twisted together into long strands. These were woven into fabrics. The early Indians wore fabrics made out of cotton that grew in the regions near the river Ganga. Flax is also a plant that gives natural fibres. In ancient Egypt, cotton as well as flax were cultivated near the river Nile and were used for making fabrics.

In those days, stitching was not known. People simply draped the fabrics around different parts of their body. Many different ways of draping fabrics were used. With the invention of the sewing needle, people started stitching fabrics to make clothes. Stitched clothes have gone through many variations since this invention. But, is it not amazing that even today saree, dhoti, lungi or turban is used as an un-stitched piece of fabric?

Just as there is a large variety in the food eaten all over our country, a large variety exists also in fabrics and clothing items.



What You have Learnt

- There is a variety of clothing material or fabric, such as, cotton, silk, wool and polyester.
- Fabrics are made from yarns, which in turn are made from fibres.
- Fibres are either natural or synthetic. Cotton, wool, silk and jute are some natural fibres, while nylon and polyester are some examples of synthetic fibres.
- Fibres like cotton and jute are obtained from plants.
- The process of making yarn from fibres is called spinning.
- Fabric from yarns is made by weaving and knitting.



Exercises

1. Classify the following fibres as natural or synthetic:
nylon, wool, cotton, silk, polyester, jute
2. State whether the following statements are true or false:
 - a. Yarn is made from fibres.
 - b. Spinning is a process of making fibres.
 - c. Jute is the outer covering of coconut.
 - d. The process of removing seed from cotton is called ginning.
 - e. Weaving of yarn makes a piece of fabric.
 - f. Silk fibre is obtained from the stem of a plant.
 - g. Polyester is a natural fibre.
3. Fill in the blanks:
 - a. Plant fibres are obtained from _____ and _____ .
 - b. Animals fibres are _____ and _____ .
4. From which parts of the plant cotton and jute are obtained?
5. Name two items that are made from coconut fibre.
6. Explain the process of making yarn from fibre.



7. How is silk obtained from a cocoon?
8. What is sericulture?
9. What are the factors which affect the quality of the wool?

SUGGESTED PROJECTS AND ACTIVITIES

1. Visit a nearby handloom or powerloom unit and observe the weaving or knitting of fabric.
2. Find out if any crop is grown in your region for obtaining fibre. If yes, what is it used for?
3. India has been a major producer of cotton and its fabric. India exports cotton fabrics and items to many other countries. Find out, how it helps us?
4. Do you know that famous Sufi Saint and poet Kabir, was a weaver? Find out about his life and teachings.
5. You can do an activity to identify the yarns of a fabric under the supervision of your teacher or parents. Pull out six to eight yarns from the fabric. Hold one end of the yarn with a tong and bring the other end over the flame of a candle. Observe carefully. Do the yarns shrink away from the flame? Do the yarns melt or burn? What type of odour is given off? Note down your observations.

If these are cotton yarns, they burn but do not shrink or melt. The burning yarn gives an odour similar to burning paper. The silk yarn shrinks away from the flame and burns but does not melt. It has the odour of charred meat. The wool yarn also shrinks and burns but does not melt. It has a strong odour of burning hair. The synthetic yarns shrink and burn. They also melt and give out an odour similar to burning plastics.

Hey!

Burning of Cotton yarn gives an odour similar to burning paper. If it is, that paper is also made from plants.



Sorting Materials into Groups

Keywords : Lustre, Translucent, Opaque, Soluble, Compress

4.1 OBJECTS AROUND US

We saw that our food and clothes have so much variety in them. Not just food and clothes, there is such a vast variety of objects everywhere. We see around us, a chair, a bullock cart, a cycle,



Fig 4.1 *Objects around us*

cooking utensils, books, clothes, toys, water, stones and many other objects. All these objects have different shapes, colours and uses (Fig. 4.1).

Look around and identify objects that are round in shape. Our list may include a rubber ball, a football and a glass marble. If we include objects that are nearly round, our list could also include objects like apples, oranges, and an earthen pitcher (gharha). Suppose we were looking for objects that are edible. We might include all the items that we have listed in Tables 1.1, 1.2 and 1.3 in Chapter 1. We might also find that some of those round shaped objects we just listed out, are also in this group.

Let us say, we wish to make a group of objects that are made of plastics. Buckets, lunch boxes, toys, water containers, pipes and many such objects, may find a place in this group. There are so many ways to group objects! In the above examples we have grouped objects on the basis of their shape or the materials they are made from.

All objects around us are made of one or more materials. These materials may be glass, metal, plastics, wood, cotton, paper, mud or soil. Can you think of more examples of materials?

Activity 1

Let us collect as many objects as possible, from around us. Each of us could get some everyday objects from home and we could also collect some objects from the classroom or from outside the school. What will we have in our collection? Chalk, pencil, notebook, rubber, duster, a hammer, nail, soap, spoke of a wheel, bat, matchbox, salt, potato! We can also list objects that we can think of, but, cannot bring to the classroom. For example, wall, trees, doors, tractor, road.

Separate all objects from this collection that are made from paper or wood. This way we have divided all objects into two groups. One group has the objects that are made from paper or wood while the other group has the objects that are not made of these materials. Similarly, we could separate the things that are used for preparing food.

Let us be a little more systematic. List all objects collected, in Table 4.1. Try to identify the materials that each one is made of. It would be fun to make this a large table – collecting information



about as many objects as possible. It may seem difficult to find out the materials out of which some of these objects are made. In such cases, discuss with your friends, teacher and parents to identify the materials.

Table 4.1 Objects and the materials they are made of

Objects	Materials they are made of
Plate	Steel, glass, plastic
Pen	Plastic, metal
Black Board	Wood, iron nails

Activity 2

Table 4.2 lists some common materials. You can also add more materials in Column 1 that are known to you. Now, try and think of everyday objects you know, that are made mainly of these materials, and list them in Column 2.

Table 4.2 Different types of objects that are made from the same material

Material	Objects made of these materials
Wood	Chair, table, Plough, tanga and its wheels
Paper	Books, notebooks, newspaper, toys, calendars
Leather	
Plastic	
Cotton	

What do we find from these tables? First, we grouped objects in many different ways. We then found that objects around us are made of different materials. At times, an object is made of a single material. An object could also be made of many materials. And then again, one material could be used for making many different objects. What decides which material should be used for making any given object? It seems that we need to know more about different materials.

4.2 PROPERTIES OF MATERIALS

Have you ever wondered why a tumbler is not made with a piece of cloth? Recall our experiments with pieces of cloth in Chapter 3 and also keep in mind that we generally use a tumbler to keep a liquid. Therefore, would it not be silly, if we were to make a tumbler out of cloth (Fig 4.2)! What we need for a tumbler is glass, plastic, metal or other such material that will hold water. Similarly, it would not be wise to use paper-like materials for cooking vessels.



Fig 4.2 Using a cloth tumbler



We see then, that we choose a material to make an object depending on its properties, and the purpose for which the object is to be used.

So, what are all the properties of materials that would be important for their usage? Some properties are discussed here.

Appearance

Materials usually look different from each other. Wood looks very different from iron. Iron appears different from copper or aluminium. At the same time, there may be some similarities between iron, copper and aluminium that are not there in wood.

Activity 3

Collect small pieces of different materials – paper, cardboard, wood, copper wire, aluminium sheet, chalk. Do any of these appear shiny? Separate the shiny materials into a group.

Now, observe as the teacher cuts each material into two pieces and look at the freshly cut surface (Fig. 4.3). What do you notice? Does the freshly cut surface of some of these materials appear shiny? Include these objects also in the group of shiny materials.

Do you notice such a shine or lustre in the other materials, cut them anyway as you can? Repeat this in the class with as many materials as possible and make a list of those with and without lustre. Instead of cutting, you can rub the surface of material with sand paper to see if it has lustre.

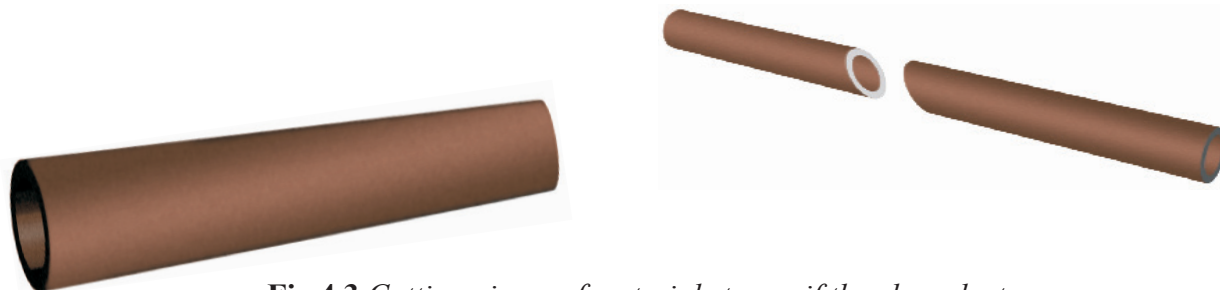

Fig 4.3 Cutting pieces of materials to see if they have lustre

Materials that have such lustre are usually metals. Iron, copper, aluminium and gold are examples of metals. Some metals often lose their shine and appear dull, because of the action of air and moisture on them. We therefore, notice the lustre, only on their freshly cut surface. When you visit an ironsmith or a workshop, look out for freshly cut surfaces of metal rods to see if they have lustre.

Hardness

When you press different materials with your hands, some of them may be hard to compress while others can be easily compressed. Take a metal key and try to scratch with it, the surface of a piece of wood, Aluminium, a piece of stone, a nail, candle, chalk, any other material or object. You can easily scratch some materials, while some cannot be scratched so easily. Materials which can



be compressed or scratched easily are called soft while some other materials which are difficult to compress are called hard. For example, cotton or sponge is soft while iron is hard.

In appearance, materials can have different properties like lustre, hardness, roughness or smoothness. Can you think of other properties that describe the appearance of a material?

Soluble or Insoluble?

Activity 4

Collect samples of some solid substances such as sugar, salt, chalk powder, sand and sawdust. Take five glasses or beakers. Fill each one of them about two-thirds with water. Add a small amount (spoonful) of sugar to the first glass, salt to the second and similarly, add small amounts of the other substances into the other glasses. Stir the contents of each of them with a spoon. Wait for a few minutes. Observe what happens to the substances added to water (Fig. 4.4). Note your observations as shown in Table 4.3.



Fig 4.4 What disappears, what doesn't?

Table 4.3 Mixing different solid materials in water

Substance	Disappears in water/does not disappear
Salt	Disappears completely in water
Sugar	
Sand	
Chalk powder	
Sawdust	

You will notice that some substances have completely disappeared or dissolved in water. We say that these substances are soluble in water. Other substances do not mix with water and do not disappear even after we stir for a long time. These substances are insoluble in water.

Water plays an important role in the functioning of our body because it can dissolve a large number of substances. Do liquids also dissolve in water?



Activity 5

Collect samples of vinegar, lemon juice, mustard oil, coconut oil, kerosene or any other liquid. Take a glass tumbler. Fill it up to half with water. Add a few spoonfull of one liquid to this and stir it well. Let it stand for five minutes. Observe whether the liquid mixes with water (Fig. 4.5). Repeat the same with other liquids, as many different liquids as are available to you. Write your observations in Table 4.4.

Table 4.4 Solubility of some common liquids in water

Liquid	Mixes well /Does not mix
Vinegar	Disappears completely in water
Lemon Juice	
Mustard oil	
Coconut oil	
Kerosene	

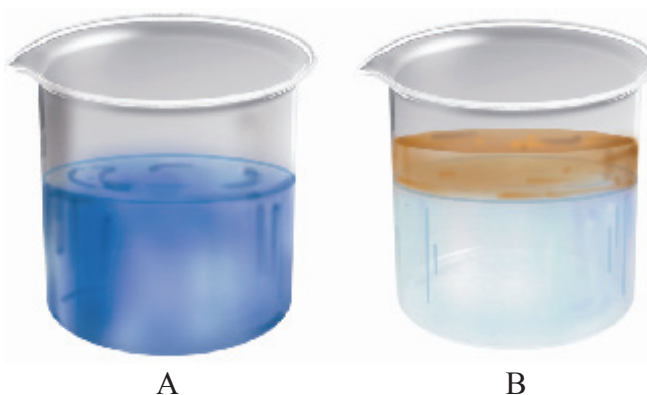

Fig 4.5 (A) some liquids mix well with water while (B) some other do not

We notice that some liquids get completely mixed with water. Some others do not mix with water and form a separate layer when kept aside for some time.

Some gases are soluble in water whereas others are not. Water usually has small quantities of some gases dissolved in it. For example, oxygen gas dissolved in water is very important for the survival of animals and plants that live in water.

Objects may float or sink in water

While doing Activity 4, you might have noticed that the insoluble solids are separated out from water. You may have also noticed this with some liquids in Activity 5. Some of these materials that did not mix with water, floated to the surface of water. Others may have sunk to the bottom of the tumbler, right? We notice many examples of objects that float in water or sink (Fig.



4.6). Dried leaves fallen on the surface of a pond, a stone that you throw into this pond, few drops of honey that you let fall into a glass of water. What happens to all of these?

What about testing these materials to see if they float or sink in other liquids like oil?

Transparency

You might have played the game of hide and seek. Think of some places where you would like to hide so that you are not seen by others. Why did you choose those places? Have you tried to hide behind a glass window? Obviously not, as your friends can see through that and spot you. Can you see through all the materials? Those substances or materials, through which things can be seen, are called transparent (Fig. 4.7).

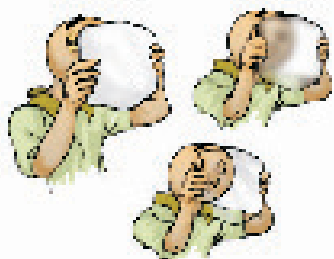

Fig 4.7 Looking through opaque, transparent and translucent material

Glass, water, air and some plastics are examples of transparent materials. Shopkeepers usually prefer to keep biscuits, sweets and other eatables in transparent containers of glass or plastic, so that buyers can easily see these items (Fig. 4.8).

On the other hand, there are some materials through which you are not able to see. These materials are called opaque. You cannot tell what is kept in a closed wooden box, a cardboard carton or a metal container. Wood, cardboard and metals are examples of opaque materials.

Do we find that we can group all materials and objects, without any confusion, as either opaque or transparent?

Activity 6

Take a sheet of paper and look through it towards a lighted bulb. Make a note of your observation. Now, put 2-3 drops of some oil and spread it on the sheet of paper. Look again towards the lighted bulb through that portion of the paper on which the oil has been spread. Do you find that the bulb is more clearly visible than before? But, can you see clearly through the oiled paper? Is everything on the other side of it visible? Perhaps not. The materials through which objects can be seen, but not clearly, are known as



Fig 4.6 Some objects float in water while others sink in it



Fig 4.8 Transparent bottles in a shop



Fig 4.9 Does torch light pass through your palm



translucent. Recall the oily patch on paper when we tested food items for presence of fats? That was translucent too! Can you think of some more examples of translucent materials?

We can therefore group materials as opaque, transparent and translucent.

Cover the glass of a torch with your palm at a dark place. Switch on the torch and observe the other side of the palm. Try to know whether palm of your hand is opaque, transparent or translucent?

We learnt that materials differ in their appearance and the way they mix in water or other liquids. They may float or sink in water or may be transparent, opaque or translucent. Materials can be grouped on the basis of similarities or differences in their properties.

Why do we need to group materials? In everyday life, we often group materials for our convenience. At home, we usually store things in such a manner that similar objects are placed together.

Such an arrangement helps us to locate them easily. Similarly, a grocer usually keeps all type of biscuits at one corner of his shop, all soaps at another while grains and pulses are stored at some other place.

There is another reason why we find such grouping useful. Dividing materials in groups makes it convenient to study their properties and also observe any patterns in these properties. We will study more about this in higher classes.



What You have Learnt

- Objects around us are made up of a large variety of materials.
- A given material could be used to make a large number of objects. It is also possible that an object could be made of a single material or of many different types of materials.
- Different types of materials have different properties.
- Some materials are shiny in appearance while others are not. Some are rough, some smooth. Similarly some materials are hard whereas some others are soft.
- Some materials are soluble in water whereas some others are insoluble.
- Some materials such as glass are transparent and some others such as wood and metals are opaque. Some materials are translucent.
- Materials are grouped together on the basis of similarities and differences in their properties.
- Things are grouped together for convenience and to study their properties.

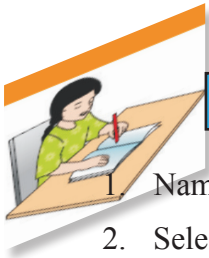

Exercises

1. Name five objects which can be made from wood.
2. Select those objects from the following which shine:
Glass bowl, plastic toy, steel spoon, cotton shirt
3. Match the objects given below with the materials from which they could be made. Remember, an object could be made from more than one material and a given material could be used for making many objects.

Objects	Materials
Book	Glass
Tumbler	Wood
Chair	Paper
Toy	Leather
Shoes	Plastics

4. State whether the statements given below are True or False.
 - (i) Stone is transparent, while glass is opaque.
 - (ii) A notebook has lustre while eraser does not.
 - (iii) Chalk dissolves in water.
 - (iv) A piece of wood floats on water.
 - (v) Sugar does not dissolve in water.
 - (vi) Oil mixes with water.
 - (vii) Sand settles down in water.
 - (viii) Vinegar dissolves in water.
5. Given below are the names of some objects and materials:
Water, basket ball, orange, sugar, globe, apple and earthen pitcher
Group them as:
 - (a) Round shaped and other shapes
 - (b) Eatables and non eatables



6. List all items known to you that float on water. Check and see if they will float on an oil or kerosene.
7. Find the odd one out from the following:
 - a) Chair, Bed, Table, Baby, Cupboard
 - b) Rose, Jasmine, Boat, Marigold, Lotus
 - c) Aluminium, Iron, Copper, Silver, Sand
 - d) Sugar, Salt, Sand, Copper sulphate

SUGGESTED ACTIVITY

1. You may have played a memory game with your friends. Several objects are placed on a table, you are asked to observe them for a few minutes, go into another room and write down the names of all objects that you can remember. Play this game, with a difference! Ask all the participants in the game to remember objects with some particular property while playing this memory game — remember and write down the names of objects that were made of wood or objects that are edible and so on. Have fun!
2. From a large collection of materials, make groups of objects having different properties like transparency, solubility in water and other properties. In later chapters you will also learn about properties of materials related to electricity and magnetism. After making different groups from the collected materials, try and find out if there are any patterns in these groups. For instance, do all materials which have lustre conduct electricity?





Separation of Substances

Keywords : Hand picking, Threshing, Winnowing, Sieving, Sedimentation, Decantation, Filtration, Evaporation, Condensation

There are many instances when we notice a substance being separated from a mixture of materials.

Tea leaves are separated from the liquid with a strainer while preparing tea (Fig. 5.1).



Fig 5.1 Separating tea leaves with a strainer

Grain is separated from stalks, while harvesting. Milk or curd is churned to separate the butter (Fig. 5.2). As we learned in Chapter 3, we gin cotton to separate its seeds from the fibre.



Perhaps you might have eaten salted daliya or poha. If you found that it had chillies in it, you may have carefully taken them out before eating.

Suppose you are given a basket containing mangoes and apples and asked to separate them. What would you do? Pick out one kind and place them in a separate container, right?

Seems easy, but what if the materials we want to separate are much smaller than mango or apple? Imagine you are given a glass of sand with salt mixed in it. Impossible, even to think of separating salt from this mixture by picking out grains of sand by hand!

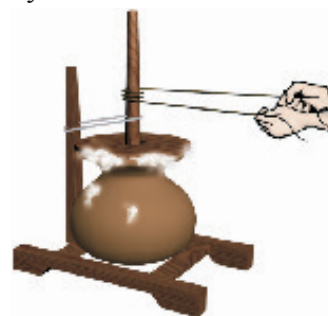

Fig 5.2 Butter is taken out by churning milk or curds

Activity 1

In Column 1 of Table 5.1, are given a few processes of separation. The purpose of separation and the way separated components are used is mentioned in Column 2 and 3 respectively. However, the information given in Columns 2 and 3 is jumbled up. Can you match each process with its purpose and the way separated components are used?

Table 5.1 Why do we separate substances?

Separation process	Purpose for which we do the separation	What do we do with the separated components
Separate stones from rice	To separate two different, but useful components	We throw away the stone component
Churning milk to obtain butter	To remove non-useful components impurities	We use both the components
Separate tea leaves	To remove impurities or harmful components	We throw away the tea leaves



We see that, before we use a substance, we need to separate harmful or non-useful substances that may be mixed with it. Sometimes, we separate even useful components if we need to use them separately.

The substances to be separated may be particles of different sizes or materials. These may be solids, liquids or even gases. So, how do we separate substances mixed together if they have so many different properties?

5.1 METHODS OF SEPARATION

We will discuss some simple methods of separating substances that are mixed together. You may come across some of these methods being used in day to day activities.

Hand Picking

Activity 2

Bring a packet of grain purchased from a shop to the classroom. Now spread the grain on a sheet of paper. Do you find only one kind of grain on the sheet of paper? Are there pieces of stone, husks, broken grain and particles of any other grain in it? Now, remove with your hand the pieces of stone, husks and other grains from it.

This method of handpicking can be used for separating slightly larger sized impurities like the pieces of dirt, stone, and husk from wheat, rice or pulses (Fig. 5.3). The quantity of such impurities is usually not very large.

In such situations, we find that handpicking is a convenient method of separating substances.

Threshing

You must have seen bundles of wheat or paddy stalks lying in fields after harvesting the crop. Stalks are dried in the sun before the grain is separated from them. Each stalk has many grain seeds attached to it. Imagine the number of grain seeds in hundreds of bundles of stalk lying in the field! How does the farmer separate grain seeds from those bundles of stalks?



Fig 5.3 Handpicking stones from grains



Fig 5.4 Threshing



One may pluck mangoes, apples or guavas from the trees. But, grain seeds are much smaller than mangoes or guavas. So, plucking them from their stalks would be impossible. How does one separate grain seeds from their stalks?

The process that is used to separate grain from stalks is called threshing. In this process, the stalks are beaten to free the grain seeds (Fig. 5.4). Sometimes, threshing is done with the help of bullocks. Machines are also used to thresh large quantities of grain.

Winnowing

Activity 3

Make a mixture of dry sand with sawdust or powdered dry leaves. Keep this mixture on a plate or a newspaper. Look at this mixture carefully. Can the two different components be made out easily? Are the sizes of particles of the two components similar? Would it be possible to separate the components by handpicking?

Now, take your mixture to an open ground and stand on a raised platform. Put the mixture in a plate or sheet of paper. Hold the plate or the sheet of paper containing the mixture, at your shoulder height. Tilt it slightly, so that the mixture slides out slowly.

What happens? Do both the components — sand and sawdust (or powdered leaves) fall at the same place? Is there a component that blows away? Did the wind manage to separate the two components?

This method of separating components of a mixture is called winnowing. Winnowing is used to separate heavier and lighter components of a mixture by wind or by blowing air. This method is commonly used by farmers to separate lighter husk particles from heavier seeds of grain (Fig. 5.5).



Fig 5.5 Winnowing

The husk particles are carried away by the wind. The seeds of grain get separated and form a heap near the platform for winnowing. The separated husk is used for many purposes such as fodder for cattles.

Sieving

Sometimes, we may wish to prepare a dish with flour. We need to remove impurities and bran that may be present in it. What do we do? We use a sieve and pour the flour into it (Fig. 5.6).

Sieving allows the fine flour particles to pass through the holes of the sieve while the bigger impurities remain on the sieve.



Fig 5.6 Sieving



Fig 5.7 Pebbles and stones are removed from sand by sieving

Activity 4

Bring a sieve and a small quantity of flour from home, to the class. Sieve the flour to separate any impurities in it. Now, make a fine powder of chalk pieces and mix it with the flour. Can we separate the flour and the powdered chalk by sieving?

Sieving is used when components of a mixture have different sizes.

Sedimentation, Decantation and Filtration

Sometimes, it may not be possible to separate components of a mixture by winnowing and handpicking. For example, there may be lighter impurities like dust or soil particles in rice or pulses. How are such impurities separated from rice or pulses before cooking?

Rice or pulses are usually washed before cooking. When you add water to these, the impurities like dust and soil particles get separated. These impurities go into water, which becomes a little muddy. Now, what will sink to the bottom of the vessel — rice or dust? Why? Have you seen that the vessel is tilted to pour out the dirty water?

When the heavier component in a mixture settles after water is added to it, the process is called sedimentation. When the water (along with the dust) is removed, the process is called decantation (Fig. 5.8). Let us find a few other mixtures that can be separated through sedimentation and decantation.

The same principle is used for separating a mixture of two liquids that do not mix with each other. If so happens in our kitchens that water gets added to the oil. Oil is not miscible with water. Since water and oil do not mix with each other. We say that oil and water are immiscible. For example, oil and water from their mixture can be separated by this process. If a mixture of such liquids is allowed to stand for some time, they form two separate layers. The component that forms the top layer can then be separated by decantation.



Fig 5.8 Separating two components of a mixture by sedimentation and decantation



Let us again consider a mixture of a solid and liquid. After preparing tea, what do you do to remove the tea leaves? Try decantation. It helps a little. But, do you still get a few leaves in your tea? Now, pour the tea through a strainer. Did all the tea leaves remain in the strainer? This process is called filtration (Fig. 5.1). Which method of separating tea leaves from prepared tea is better, decantation or filtration?

Let us now consider the example of water that we use. Do all of us, at all times, get safe water to drink? Sometimes, water supplied through taps may be muddy. The water collected from ponds or rivers may also be muddy, especially after rains. Let us see if we can use some method of separation to remove insoluble impurities like soil from the water.

Activity 5

Collect some muddy water from a pond or a river. If it is not available, mix some soil to water in a glass. Let it stand for half an hour. Observe the water carefully and note your observations.

Does some soil settle at the bottom of water? Why? What will you call this process?

Now, slightly tilt the glass without disturbing the water. Let the water from the top flow into another glass (Fig. 5.8). What will you call this process?

Is the water in the second glass still muddy or brown in colour? Now filter it. Did the tea strainer work? Let us try filtering the water through a piece of cloth. In a piece of cloth, small holes or pores remain in between the woven threads. These pores in a cloth can be used as a filter.

If the water is still muddy, impurities can be separated by a filter that has even smaller pores. A filter paper is one such filter that has very fine pores in it.

Fig. 5.9 shows the steps involved in using a filter paper. A filter paper folded in the form of a cone is fixed onto a funnel (Fig. 5.10). The mixture is then poured on the filter paper. Solid particles in the mixture do not pass through it and remain on the filter.



Fig 5.9 Folding filter paper to make a cone

Fruit and vegetable juices are usually filtered before drinking to separate the seeds and solid particles of pulp. The method of filtration is also used in the process of preparing cottage cheese (paneer) in our homes. You might have seen that for making paneer, a few drops of lemon juice are added to milk as it boils. This gives a mixture of particles of solid paneer and a liquid. The paneer is then separated by filtering the mixture through a fine cloth or a strainer.



Fig 5.10 Filtration using a filter paper



Evaporation

Activity 6

Heat a beaker containing some water. Allow the water to boil. If you continue heating, would the water turn into steam and disappear completely? Now, add two spoons of salt to water in another beaker and stir it well. Do you see any change in the colour of water? Can you see any salt in the beaker, after stirring? Heat the beaker containing the salt water (Fig. 5.11). Let the water boil away. What is left in the beaker?

In this activity, we used the process of evaporation, to separate a mixture of water and salt.

The process of conversion of water into its vapour is called evaporation. The process of evaporation takes place continuously wherever water is present. Where do you think, salt comes from? Sea water contains many salts mixed in it. One of these salts is the common salt. When



Fig 5.11 Heating a beaker containing salt water



Fig 5.12 Obtaining salt from sea water

sea water is allowed to stand in shallow pits, water gets heated by sunlight and slowly turns into water vapour, through evaporation. In a few days, the water evaporates completely leaving behind the solid salts (Fig. 5.12). Common salt is then obtained from this mixture of salts by further purification.

Use of more than one method of separation

We have studied some methods for separation of substances from their mixtures. Often, one method is not sufficient to separate the different substances present in a mixture. In such a situation, we need to use more than one of these methods.

Activity 7

Take a mixture of sand and salt. How will we separate these? We already saw that handpicking would not be a practical method for separating these.

Keep this mixture in a beaker and add some water to it. Leave the beaker aside for some time. Do you see the sand settling down at the bottom? The sand can be separated by decantation or filtration. What does the decanted liquid contain? Do you think this water contains the salt which was there in the mixture at the beginning?



Now, we need to separate salt and water from the decanted liquid. Transfer this liquid to a kettle and close its lid. Heat the kettle for some time. Do you notice steam coming out from the spout of the kettle?

Take a metal plate with some ice on it. Hold the plate just above the spout of the kettle as shown in Fig. 5.13. What do you observe? Let all the water in the kettle boil off.

When the steam comes in contact with the metal plate cooled with ice, it condenses and forms liquid water. The water drops that you observed falling from the plate, were due to condensation of steam. The process of conversion of water vapour into its liquid form is called condensation.

Did you ever see water drops condensed under a plate that has been used to cover a vessel containing milk that has just been boiled?

After all the water has evaporated, what is left behind in the kettle?

We have thus, separated salt, sand and water using processes of decantation, filtration, evaporation and condensation.

Can water dissolve any amount of a substance?

In chapter 4, we found that many substances dissolve in water and form a solution. We say that these substances are soluble in water. What will happen if we go on adding more and more of these substances to a fixed quantity of water?

Activity 8

You will need a beaker or a tumbler, a spoon, salt and water. Pour half a cup of water in the beaker. Add one teaspoonful of salt and stir it well, until the salt dissolves completely (Fig 5.14). Again add a teaspoonful of salt and stir well. Go on adding salt, one teaspoonful at a time, and stir.

After adding a few spoons of salt, do you find that some salt remains undissolved and settles at the bottom of the beaker? If yes, this means that no more salt can be dissolved in the amount of water we have taken. The solution is now said to be saturated.

Activity 9

Take some water in a beaker and mix salt in it until it cannot dissolve any more salt. This will give you a saturated solution of salt in water.

Now, add a small quantity of salt to this saturated solution and heat it. What do you find? What happens to the undissolved salt in the bottom of the beaker? Does it dissolve, now? If yes,



Fig 5.13 Evaporation and condensation



Fig 5.14 Dissolving salt in water



can some more salt be dissolved in this solution by heating it?

Let this hot solution cool. Does the salt appear to settle at the bottom of the beaker again?

The activity suggest that larger quantity of salt can be dissolved in water on heating.

Does water dissolve equal amounts of different soluble substances? Let us find out.

Activity 10

Take two glasses and pour half a cup of water in each of them. Add a teaspoon of salt to one glass and stir till the salt dissolves. Go on adding salt, one teaspoon at a time, till the solution saturates. Record the number of spoons of salt that dissolved in the water, in Table 5.2. Now, repeat the same activity with sugar. Repeat this with some other substances that are soluble in water.

What do you notice from Table 5.2? Do you find that water dissolves different substances in different amounts?

Table 5.2

Substance	Number of spoons of substance that dissolve in water
Salt	
Sugar	

We have discussed a few methods of separating substances. Some of the methods of separation presented in this chapter are also used in a science laboratory.

We also learnt that a solution is prepared by dissolving a substance in a liquid. A solution is said to be saturated if it cannot dissolve more of the substance in it.



What You have Learnt

- Handpicking, winnowing, sieving, sedimentation, decantation and filtration are some of the methods of separating substances from their mixtures.
- Husk and stones could be separated from grains by handpicking.
- Husk is separated from heavier seeds of grain by winnowing.
- Difference in the size of particles in a mixture is utilised to separate them by the process of sieving and filtration.



- In a mixture of sand and water, the heavier sand particles settle down at the bottom and the water can be separated by decantation.
- Filtration can be used to separate components of a mixture of an insoluble solid and a liquid.
- Evaporation is the process in which a liquid gets converted into its vapour. Evaporation can be used to separate a solid dissolved in a liquid.
- A saturated solution is one in which no more of that substance can be dissolved.
- More of a substance can be dissolved in a solution by heating it.
- Water dissolves different amount of soluble substances in it.



Exercises

1. Why do we need to separate different components of a mixture? Give two examples.
2. What is winnowing? Where is it used?
3. How will you separate husk or dirt particles from a given sample of pulses before cooking.
4. What is sieving? Where is it used?
5. How will you separate sand and water from their mixture?
6. Is it possible to separate sugar mixed with wheat flour? If yes, how will you do it?
7. How would you obtain clear water from a sample of muddy water?
8. Fill up the blanks
 - a. The method of separating seeds of paddy from its stalks is called _____.
 - b. When milk, cooled after boiling, is poured onto a piece of cloth the cream (malai) is left behind on it. This process of separating cream from milk is an example of _____.
 - c. Salt is obtained from seawater by the process of _____.
 - d. Impurities settled at the bottom when muddy water was kept overnight in a bucket. The clear water was then poured off from the top. The process of separation used in this example is called _____.
9. True or false?
 - a. A mixture of milk and water can be separated by filtration.



- b. A mixture of powdered salt and sugar can be separated by the process of winnowing.
 - c. Separation of sugar from tea can be done with filtration.
 - d. Grain and husk can be separated with the process of decantation.
10. Lemonade is prepared by mixing lemon juice and sugar in water. You wish to add ice to cool it. Should you add ice to the lemonade before or after dissolving sugar? In which case would it be possible to dissolve more sugar?
11. Mustard oil gets accidentally mixed with water. How will you remove mustard oil from the water?
12. A tiny iron drill of a carpenter falls into a heap of straw. Suggest a convenient way of recovering the drill?
13. Differentiate between a saturated solution and unsaturated solution?

SUGGESTED PROJECTS AND ACTIVITIES

1. Visit a nearby dairy and report about the processes used to separate cream from milk.
2. You have tried a number of methods to separate impurities like mud from water. Sometimes, the water obtained after employing all these processes could still be a little muddy. Let us see if we can remove even this impurity completely. Take this filtered water in a glass. Tie a thread to a small piece of alum. Suspend the piece of alum in the water and swirl. Did the water become clear? What happened to the mud? This process is called loading. Talk to some elders in your family to find out whether they have seen or used this process.





Changes Around us

Keywords : Microbes, Fermentation, Water-Lodged, POP

What fun, if you suddenly get some magical powers to change anything around you. What are the things you would want to change?

We do not have magical powers. But, we can still change a few things around us, perhaps many things. Can you list a few things you can change around you, with no magic involved?

Many changes are taking place around us on their own. In the fields, the crops change from time to time. Sometimes, leaves fall from trees change colour and dry out. The flowers bloom and then wither away. Are any changes happening in your body? Your nails grow, your hair grows, you grow taller and your weight increases as you grow. Did you realise earlier that so many changes are taking place around you all the time?



Can some of the changes be grouped together?

How can we group various changes? It might help, if we find some similarities between them.

6.1 CAN ALL CHANGES ALWAYS BE REVERSED?

Activity 1

- Take a balloon and blow it. Take care that it does not burst. The shape and size of the balloon have changed (Fig. 6.1). Now, let the air escape the balloon.



Fig 6.1 A balloon changes its size and shape on blowing air into it





Activity 2

- Take a piece of paper and fold it as shown in Fig.6.2. You have changed the sheet of paper into a toy aeroplane. You may have lots of fun in flying this plane. Once you are tired of it, unfold the paper again.



Fig 6.2 A toy aeroplane made by folding paper

Activity 3

- Take some dough and make a ball. Try to roll out a roti (Fig. 6.3). May be you are not happy with its shape and wish to change it back into a ball of dough again.

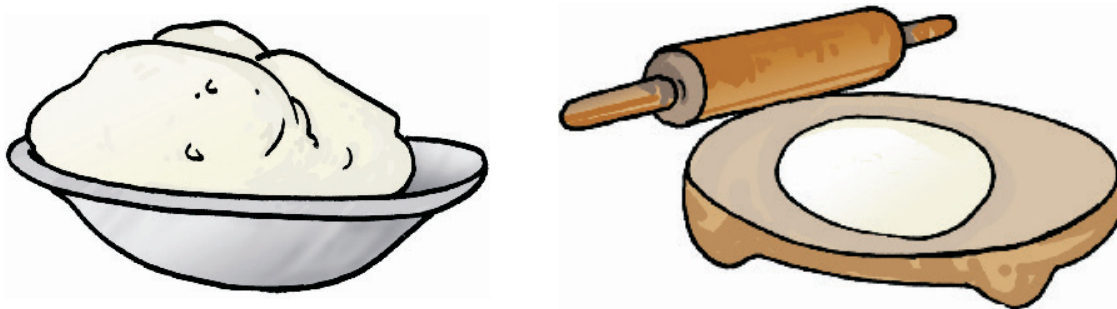

Fig 6.3 A ball of dough and a rolled out roti

Now, think about the three changes you observed in Activity 1, 2 and 3. What do they have in common?

Was it possible to get the balloon back to its original shape and size?

Was the size of the paper same as before and after making an aeroplane?

Was it possible to get back the ball of dough again?

What do you conclude? In each of the three activities, is it possible to get back to the material with which we started our activity? If the answer is yes, it means that the changes occurring in these activities can be reversed. Now, let us repeat the same activities with a difference.



Activity 4

- Take the same balloon, which you used in Activity 1. Blow it to its full size and tie its mouth with a string tightly. Prick it with the pointed tip of your pencil. Oops! It burst.

Activity 5

- Take the same piece of paper, which you used in Activity 2. Draw an aeroplane on it and cut along its outline (Fig.6.4).

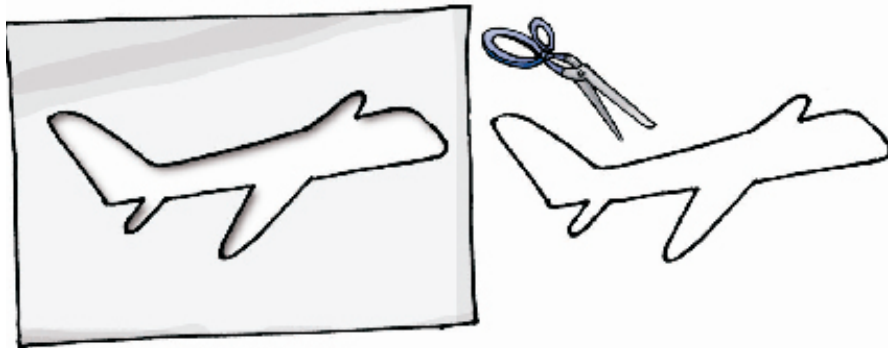

Fig 6.4 An aeroplane cut out of paper

Activity 6

- Roll out a roti from the ball of dough again and bake it on a tawa (Fig.6.5).



Fig 6.5 A roti

Suppose, you are asked the same three questions which you answered after Activity 3. What would your answers be, now?

We see that, the changes which have occurred in the Activity 4, 5 and 6 can not be reversed.

You use a pencil and an eraser. With repeated use, their shape and size changes. Can we reverse this change? You must have seen a potter working on his wheel. He shapes a lump of clay into a pot. Can this change be reversed? He then bakes the pot in an oven. Now, can this change be reversed?



Some common changes are given in Table 6.1. Which of these changes, do you think can be reversed?

We find that one way we can group changes is to see if they can be reversed.

Table 6.1 Some common changes

Change	Can be reversed Yes/No
Raw egg to boiled egg	
Flour to bread	
Wet clothes to dry clothes	
Woolen yarn to knitted sweater	
Grain to its flour	
Cold milk to hot milk	
Straight string to a coiled string	
Bud to flower	
Milk to paneer	
Cowdung to biogas	
Stretched rubber band to its normal size	
Ice cream to molten ice cream	

6.2 COULD THERE BE OTHER WAYS TO BRING A CHANGE?

We all have seen the tools which are used to dig the soil (Fig. 6.6). Have you ever seen how the iron blade in these tools is fixed to the wooden handle?

The iron blade of these tools has a ring in which the wooden handle is fixed. Normally, the ring is slightly smaller in size than the wooden handle. To fix the handle, the ring is heated and it becomes slightly larger in size (expands). Now, the handle easily fits into the ring. When the ring cools down it contracts and fits tightly on to the handle.

Such a change is also used for fixing the metal rim on a wooden wheel of a cart as shown in Fig.6.7. Again the metal rim is made slightly smaller than the wooden wheel.



Fig 6.6 Tools are often heated before fixing wooden handles



On heating, the rim expands and fits onto the wheel. Cold water is then poured over the rim, which contracts and fits tightly onto the wheel.

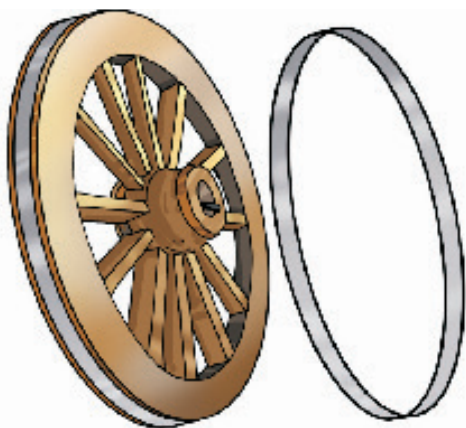

Fig 6.7 Cart wheel with metal rim fixed to it

More to Know

Louis Pasteur. A French Scientist studied microbes and was perhaps the first to give an idea that microbes are responsible for the decay of organic matter and for many diseases. He helped us with the knowledge of Fermentation and making of Vaccines.

He is known for his outstanding contribution in Fermentation and invention of vaccine.

When we heat water in a pan, it begins to boil after some time. If we continue to heat further, the quantity of water in the pan begins to decrease.

The water changes into its vapour. In Activity 7, Chapter 5 you have observed that water vapour gets changed into liquid water when it is cooled. We all have noticed melting of ice. Ice melts when it is heated. What does it change into? Is it possible to change this water back into ice?

Let us observe some more changes.

Activity 7

- Take a small candle and measure its length with a scale. Now, fix it at a suitable place and light it. Let it burn for some time. Now blow out the candle and measure its length again (Fig.6.8).

Can the change in the length of the candle be reversed? If we were to take some wax in a pan and heat it, can this change be reversed (Fig. 6.9)



Fig 6.8 Burning of candle

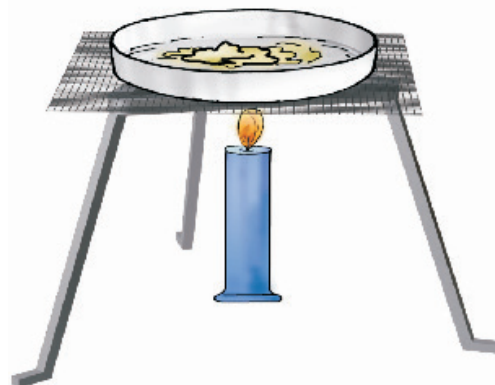

Fig 6.9 Heating wax



Repeat Activity 7 with an incense stick. Wait till it burns away completely. What are the changes that occur in the incense stick? The stick burns to produce some new material. These are ash and some gases. We cannot see these gases but can sense them due to their pleasant smell. Can this change be reversed? And what about the change, which occurred in the matchstick you used for lighting the candle or incense stick?

So far we have discussed the changes occurring in a given object or its material. What about the changes that occur when two substances are mixed together?

In Chapter 4, we dissolved salt in water. Do you think a change occurred in salt or in water? Is it possible to reverse this change? Wait, in Chapter 5, we learnt how to separate salt from its solution in water. So, can we say that the change due to dissolving salt in water be reversed?

If you have ever seen curd being set. A small quantity of curd is added to warm milk. The milk is stirred and is set aside for a few hours at a warm place. In a few hours, the milk changes into curd. Can this change be reversed?

We find that a few ways to bring about a change in a substance could be, by heating it or by mixing it with some other substance. We also find that some changes can be reversed, while some others cannot be reversed. There must be many other ways of changing things around us. It is possible that some of them could be reversed. Thus, changes around us could be grouped as those that can be reversed or cannot be reversed. In higher classes, you will learn more about the ways in which changes can be made and the way these can be grouped.



What You have Learnt

- Some changes can be reversed and some cannot be reversed.
- A change may occur by heating a substance or by mixing it with some other.



Exercises

1. To walk through a waterlogged area, you usually shorten the length of your dress by folding it. Can this change be reversed?
2. You accidentally dropped your favourite toy and broke it. This is a change you did not want. Can this change be reversed?
3. Some changes are listed in the following table. For each change, write in the blank column, whether the change can be reversed or not.



S.No	Change	Can be reversed (Yes/No)
1.	The sawing of a piece of wood	
2.	The melting of ice candy	
3.	Dissolving sugar in water	
4.	The cooking of food	
5.	The ripening of mango/tomato	
6.	Souring of milk	

4. A drawing sheet changes when you draw a picture on it. Can you reverse this change?
5. Give examples to explain the difference between changes that can or cannot be reversed.
6. A thick coating of a paste of Plaster of Paris (POP) is applied over the bandage on a fractured bone. It becomes hard on drying to keep the fractured bone immobilised. Can the change in POP be reversed?
7. A bag of cement lying in the open gets wet due to rain during the night. The next day the sun shines brightly. Do you think the changes, which have occurred in the cement, could be reversed?
8. Formation of snow is physical change. Explain
9. Burning of an incense stick is a chemical change. Explain?

SUGGESTED PROJECTS AND ACTIVITIES

1. Take a lemon, a paintbrush and a piece of paper. Cut the lemon and squeeze out its juice in a cup. Dip the brush in the lemon juice and write a message on the paper. Let the paper dry and you find that the letters of your message become invisible. Now, press the paper with hot iron or warm it by holding it above the flame of a candle (Take care that it does not catch fire). As the paper gets warm, invisible letters change into dark brown colour. Identify the changes that can be reversed.
2. Observe preparation of dishes at your home. Identify two changes that can be reversed.
3. Maintain a record for one year of the seasonal changes in vegetables, clothing, nature and events around you. Identify the changes that can or cannot be reversed.



Getting to Know Plants

Keywords : Venation, Transpiration, Xerophytic, Weeds, Pistil, Stamen

Go outside and observe all the plants around you. Do you see that some plants are small, some very big, while some are just patches of green on the soil? Some have green leaves, while some others have reddish ones. Some have huge red flowers; some have tiny blue ones, while some have none. We do see a variety of plants existing all around us — near our homes, in the school ground, on the way to the school, in the parks and gardens, isn't it?



Fig 7.1 Parts of a plant

Let us get to know the different parts of any plant. This will help us understand the differences between plants of different kinds. Can you label the stem, branches, roots, leaves, and flowers of the plant shown in Fig.7.1? Colour the parts of the plant.



Fig 7.2 A Nature walk!

Let us now go on a Nature walk, make friends with many different kinds of plants and examine them closely (Fig. 7.2).

7.1 HERBS, SHRUBS AND TREES

Activity 1

Look closely at the stem and branches of:

1. Plants much smaller than you.
2. Plants that are about your size, and
3. Plants which are much taller than you.

Feel their stem and try to bend them gently to see if they are tender or hard. Take care that the stem does not break. Hug the tall plants to see how thick their stems are!

We also need to notice from where the branches grow in some plants — close to the ground or higher up on the stem.

We will now group all the plants we observed, in Table 7.1. Some examples are shown. You can fill the Columns 1, 2 and 3 for many more plants. Fill Column 4 after you have studied later part of this section.





Table 7.1 Categories of Plants

Plant Name	Column 1 Height	Column 2 Stem				Column 3 Where do the branches appear		Column 4
		Green	Tender	Thick	Hard	At the base of the stem	Higher up on the stem	
								Category of plant
Tomato	Shorter than me	yes	yes					herb
Mango	Much taller than me			yes	yes		yes	tree
Lemon	Slightly taller than me				yes	yes		shrub
Apple								

Based on these characters most plants can be classified into three categories: herbs, shrubs and trees. An example of each is shown in Fig.7.3.

Plants with green and tender stems are called herbs. They are usually short and may not have many branches [Fig.7.3 (a)].

Some plants have the stem branching out near the base. The stem is hard but not very thick. Such plants are called shrubs [Fig .7.3(b)].

Some plants are very tall and have hard and thick brown stem. The stems have branches in the upper part, much above the ground. Such plants are called trees [Fig.7.3(c)].



(a)



(b)



(c)

Fig 7.3 (a) Herb (b) Shrub (c) Tree

Based on the above characteristics can you now correctly classify the plants listed by you and complete column 4 in Table 7.1?

Plants with weak stems that cannot stand upright and spread on the ground are called creepers, while those that take support on neighbouring structures and climb up are called climbers (Fig.7.4). These are different from the herbs, shrubs and trees.

Perhaps there are some plants in your school or at home that you take care of. Write down the names of any two trees, shrubs, herbs or creepers growing in your house or school.



Fig 7.4 Climbers

7.2 STEM

Activity 2

We would require a glass, water, red ink, a herb, and a blade for this activity.

Pour water to fill one-third of the glass. Add a few drops of red ink to the water. Cut the base of the stem of the herb and put it in the glass as shown in Fig.7.5. Observe it the next day.



Fig 7.5 What does the stem do

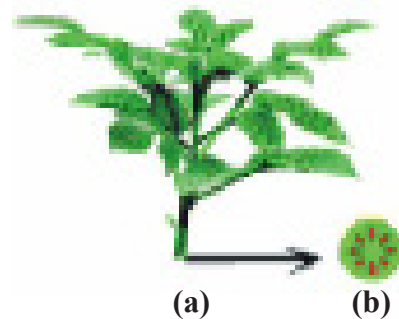

Fig 7.6(a) Water moves up the bottom (b) enlarged view of open end of stem



Do any of the parts of the herb appear to have red colour? If yes, how do you think the colour reached there?

You can cut the stem across and look for the red colour inside the stem (Fig. 7.6).

From this activity we see that water moves up the stem. In other words, stem conducts water. Just like the red ink, minerals dissolved in water also move up in the stem, along with the water. The water and minerals go to leaves and other plant parts attached to the stem, through narrow tubes inside the stem.

Activity:

This activity could be done with herbs having white flowers. Put one branch with a white flower in the water in glass A and add a few drops of red ink to the water. Do a funny thing with another branch. Split it half way along its length and put the two ends in the water in glasses B and C (Fig. 7.7). Put a few drops of red ink in glass B and blue ink in glass C. Guess what would happen to the flower in glass A and the flower put jointly in B and C.

When you had cut across the stem in Activity 2, did you notice a number of spots of red colour arranged in a ring inside the stem?

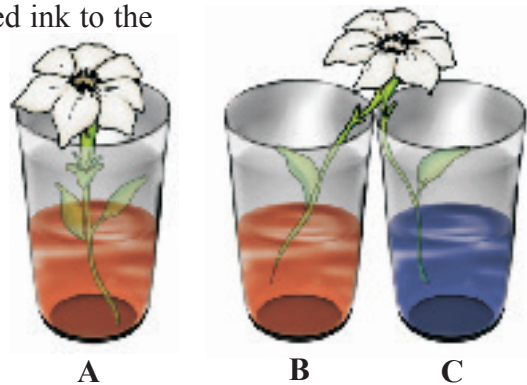

Fig 7.7 Flowers

More to Know

Potato, although remaining inside the soil, is not a root. It is a stem bearing nodes and internodes

7.3 LEAF

Look at leaves of plants around you and draw them in your notebook. Are all the leaves the same in size, shape and colour?

How are they attached to the stem? The part of a leaf by which it is attached to the stem is called petiole. The broad, green part of the leaf is called lamina (Fig. 7.8). Can you identify these parts of the leaves in plants around you? Do all the leaves have petioles?

Let us get to know the leaf better by taking its impression! If you thought that leaves cannot sign, here is an activity which will make you think again.



Fig 7.8 A leaf



Activity 3

Put a leaf under a white sheet of paper or a sheet in your notebook. Hold it in place as shown in Fig. 7.9. Hold your pencil tip sideways and rub it on the portion of the paper having the leaf below it. Did you get an impression with some lines in it? Are they similar to those on the leaf?

These lines on the leaf are called veins. Do you see a thick vein in the middle of the leaf? This vein is called the midrib. The design made by veins in a leaf is called the leaf venation. If this design is net-like on both sides of midrib, the venation is reticulate [Fig. 7.10 (a)]. In the leaves of grass you might have seen that the veins are parallel to one another. This is parallel venation [(Fig. 7.10 (b)]. Observe the venation in as many leaves as you can without removing them from the plant. Draw the pattern and write names of some plants having reticulate and parallel venation.

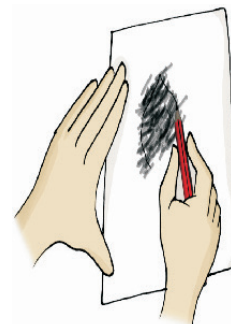

Fig 7.9 Taking an impression of a leaf

Shall we now find out some of the functions of a leaf?



(a)



(b)

Fig 7.10 Leaf venation (a) reticulate and (b) parallel

Activity 4

We will require a herb, two transparent polythene bags and some string.

Do this activity during day time on a sunny day. Use a healthy, well watered plant that has been growing in the sun, for this activity. Enclose a leafy branch of the plant in a polythene bag and tie up its mouth as shown in Fig. 7.11. Tie up the mouth of another empty polythene bag and keep it also in the sun.

After a few hours, observe the inner surface of the bags. What do you see? Are there any droplets of water in any of the bags? Which bag has the droplets? How do you think they got there? [Don't forget to remove the polythene bag after the activity!]

Water comes out of leaves in the form of vapour by a process called **transpiration**. Plants release a lot of water into the air through this process. We will learn more about this in Chapter 14.



Fig 7.11 What does the leaf do?



Why did we tie a bag around the leaves? Would we have seen the water from the transpiration of plants otherwise? What makes the water appear on the polythene bag? In Chapter 5, we noticed water changing into different forms in some of our activities. Can you think of these and name the process that makes water drops appear on the polythene bag?

Leaves also have another function. Let us study this.



CAUTION!

Do not touch a cactus plant:
The leaves are reduced to spines in it.
Being a xerophytic plant, this modification helps it to reduce water loss from the plant body.



Activity 5

We would require a leaf, spirit, a beaker, test tube, burner, water, a plate and iodine solution for this activity.

Put a leaf in a test tube and pour spirit to completely cover the leaf. Now, put the test tube in a beaker half filled with water. Heat the beaker till all the green colour from the leaf comes out into the spirit in the test tube. Take out the leaf carefully and wash it in water. Put it on a plate and pour some iodine solution over it (Fig. 7.12).



Fig 7.12 *What does the leaf contain*

What do you observe? Compare your observations with those done in Chapter 2, when you tested food for presence of different nutrients. Does this mean that the leaf has starch in it?

In Chapter 2, we saw that a slice of raw potato also shows the presence of starch. Potatoes get this starch from other parts of the plant and store it. However, leaves prepare their food in the presence of sunlight and a green coloured substance present in them. For this, they use water and carbon dioxide from air. This process is called photosynthesis. Oxygen is given out in this process. The food prepared by leaves ultimately gets stored in different parts of plant.

How do we know that the leaf has prepared the starch and not received it from another part of the plant? To test this, the above activity can be repeated with a little difference.

Place a potted plant with green leaves, in a dark room for a day or two. Now, cover a portion of a leaf of the plant completely with black paper and leave the plant in the Sun for a day. Remove the leaf covered in black paper and repeat the test for starch.

What do you see? Which part of the leaf shows the presence of starch? Does this help us



understand that leaves produce starch in the presence of sunlight?

We see that the stem supplies leaf with water. The leaf uses the water to make food. The leaves also lose water through transpiration. How do the stem and leaves get the water? That is where the roots come in!

7.4 ROOT

Look at Fig. 7.13. Who do you think is watering their plant correctly, A or B? Why?

Which part of the plant is in the soil? Let us learn more about this part from the following activities.

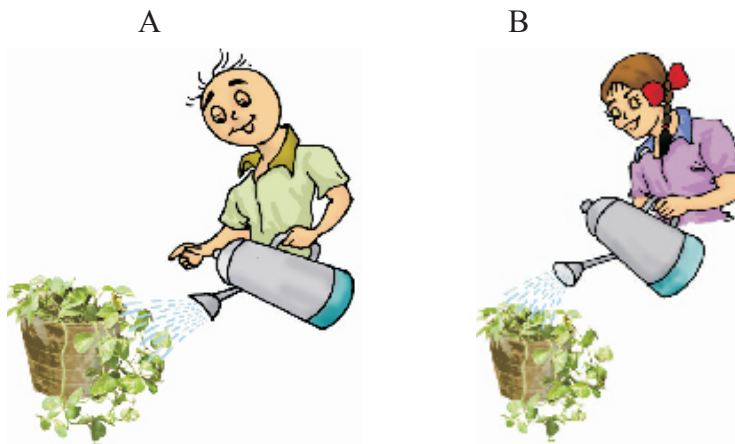

Fig 7.13 Watering the plants

Activity 6

☒ You would require two pots, some soil, khurpi (for digging), blade or a pair of scissors and water. This activity is to be done in groups of 4-5 students.

Select two weeds of the same kind from an open ground and dig them out. Take care that their roots do not break. Plant one of the weeds in the soil in pot A [Fig. 7.14 (a)]. Cut off the roots from the other weed and plant and put it in the soil in pot B [Fig. 7.14 (b)]. Water them regularly. Observe the plants after a week. Are both plants healthy?

Both the plants are watered regularly, but, one is without roots, isn't it? Does this activity help you to understand an important function of the root?

Let us do an activity to study another function of root.

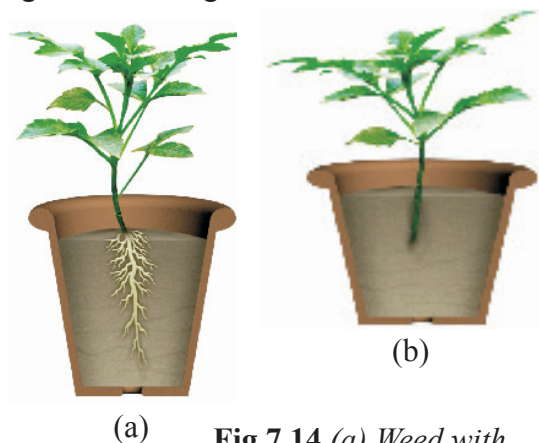

Fig 7.14 (a) Weed with roots and (b) without roots



Activity 7

We would require seeds of gram and maize, cotton wool, katori and some water.

Take two katoris. Place some wet cotton wool in them. Put 3 or 4 seeds of gram in one and maize in the other. Keep the cotton wet by sprinkling water every day, until the sprouts have grown into young plants. After a week try to separate the young plants from the cotton wool (Fig. 7.15).

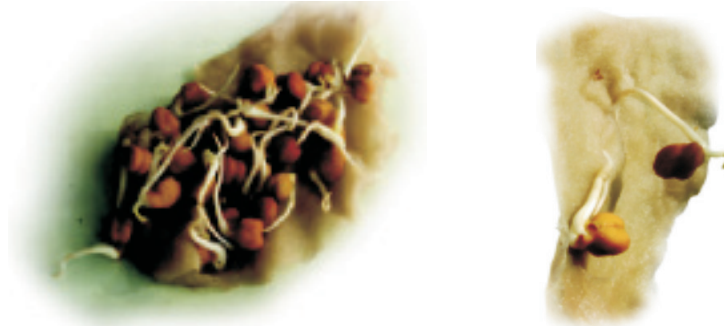

Fig 7.15 Young plants grown on Cotton wool

Was it easy to separate the cotton wool from the roots? Why?

In Activity 6, we could not easily pull out the plants from the soil, right? We dug them out. The roots help in holding the plant firmly in the soil. They are said to anchor the plant to the soil. You have seen that there are different kinds of stems and leaves. Do the roots also show a variety? Let us find out.

Activity 8

Study Fig. 7.16 (a) and (b) carefully. Now, look at the roots of the gram plants you have pulled out from the cotton wool. Do they look like the roots shown in Fig. 7.16 (a) or those in Fig. 7.16 (b)? How about the roots of the maize plant? Write 'gram' or 'maize' in the blank spaces in the figure after matching the roots with the figures.

In what way are the roots of gram and maize similar? In what way are they different? There seem to be two different types of roots, isn't it? Are there also other types of roots? Let us find out.



Fig 7.16 (a) Roots of ----- (b) Roots of -----



Activity 9

Go to an open ground where many weeds are growing. Dig out a few weeds, wash the soil off the roots and observe them. Do you find that all the weeds that you have dug out have either the kind of roots shown in Fig. 7.17 (a) or as in Fig. 7.17 (b)?

For roots of the kind shown in Fig.7.17 (a), the main root is called tap root and the smaller roots are called lateral roots. Plants with roots as shown in Fig. 7.17 (b) do not have any main root. All roots seem similar and these are called fibrous roots.

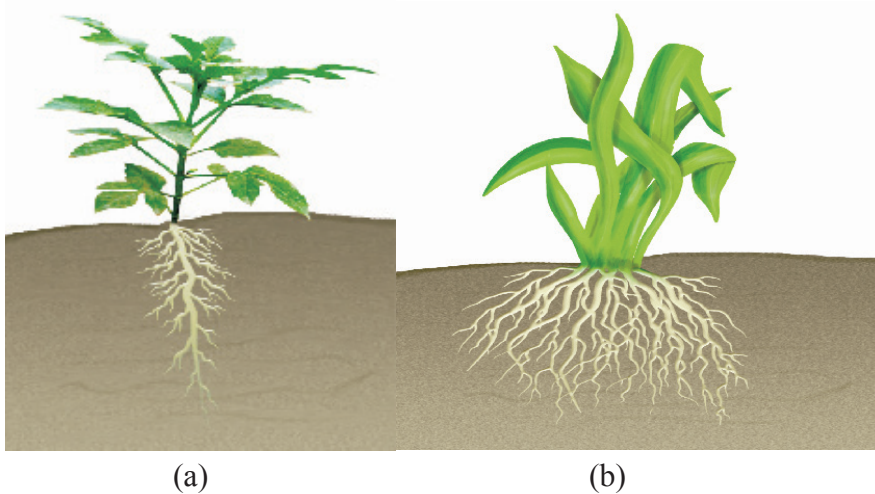

A Brilliant Idea

If you want to know what kind of roots a plant has, you need not pull it out. You just have to look at its leaves.

Fig 7.17 (a) Taproot (b) fibrous root

Separate the weeds you have collected into two groups. In group (a) put those that have tap roots and in group (b) those that have fibrous roots. Look at the leaves of the plants in Group (a). What kind of venation do they have? What kind of venation do you see for plants of Group (b)?

Do you notice that leaf venation and the type of roots in a plant are related in a very interesting way? In Table 7.2, can you match the type of leaf venation and the type of roots for some plants you have studied in all the activities so far?

Table 7.2 Types of roots and types of leaf venation

Name of plant	Type of leaf venation	Type of roots



We have learnt that roots absorb water and minerals from the soil and the stem conducts these to leaves and other parts of the plant. The leaves prepare food.

This food travels through the stem and is stored in different parts of a plant. We eat some of these as roots— like carrot, radish, sweet potato, turnip and tapioca. We also eat many other parts of a plant where the food is stored.

Do you agree that stem is like a two way street? Write down the name of material that goes up the stem and that which comes down, in Fig. 7.18.

In the next section, we will study about the structure of a flower.

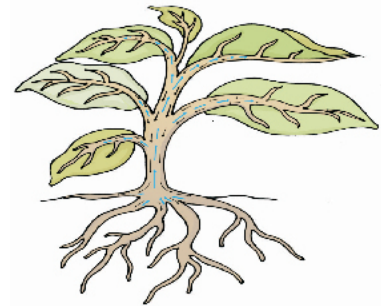

Fig 7.18 A stem as a two way street

7.5 FLOWER

You are shown three branches of a rose in Fig 7.19 (a), (b) and (c). Which one will help you best to recognize the plant?

Which colour did you use for the flower in Fig. 7.19? Are all flowers colourful? Have you ever seen flowers on the plants of grass, wheat, maize, mango or guava? If you see any flowers in these plants, are they brightly coloured?

Let us study a few flowers closely.

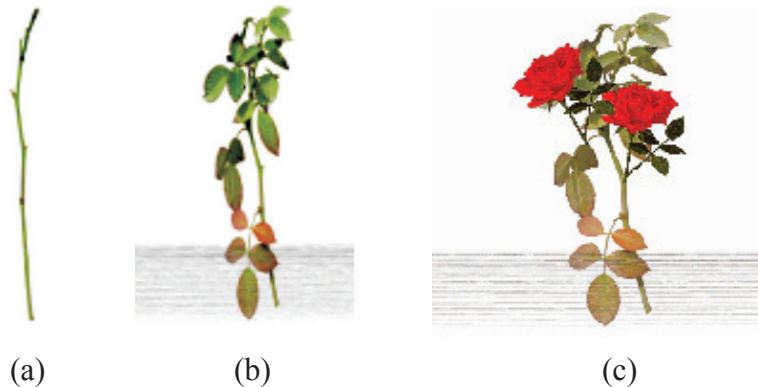

Fig 7.19 Rose (a) A leaf less branch (b) a branch with leaves (c) A branch with leaves and flowers

Activity 10

We would require one bud and two fresh flowers each, of any of the following– Datura, china rose, mustard, brinjal, lady’s finger, gulmohur. Also a blade, a glass slide or a sheet of paper, a magnifying glass and water.



Observe Fig. 7.20 carefully. Look at the prominent parts of the open flower. These are the petals of the flower. Different flowers have petals of different colours.

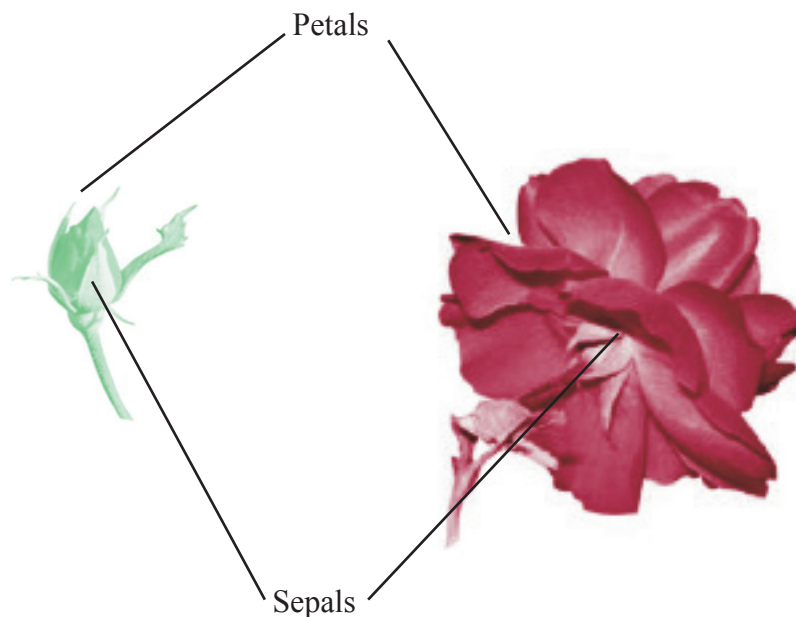

Fig 7.20 *Bud and Flower*

Where do you think the petals are in a closed bud? Which is the most prominent part in a bud? Did you see that this part is made of small leaf-like structures? They are called sepals. Take a flower and observe its petals and sepals. Now, answer the following questions:

How many sepals does it have?

Are they joined together?

What are the colours of the petals and the sepals?

How many petals does your flower have?

Are they joined to one another or are they separate?

Do the flowers with joined sepals have petals that are separate or are they joined together?

Make a table based on the observations of the whole class (Table 7.3). Add observations to this table, from a field trip to a locality where there are plants with flowers. Fill the last two columns after you have gone through the entire section.



Table 7.3 Observations of flowers

Name of Flower	Number and colour of petals	Number and colour of sepals	Are the sepals joined together or separate?	Are Stamens free or joined to petals?	Petal Present/Absent
Rose	Many (colour)	5 (colour)?	Separate	Free	Present

To see the inner parts of the flower clearly, you have to cut it open, if its petals are joined. For example, in datura and other bell shape flowers, the petals have to be cut lengthwise and spread out so that the inner parts can be seen clearly (Fig. 7.21).

Remove the sepals and petals to see the rest of the parts. Study the Fig. 7.22 carefully, compare your flower with the illustration and identify the stamens and pistil in your flower.

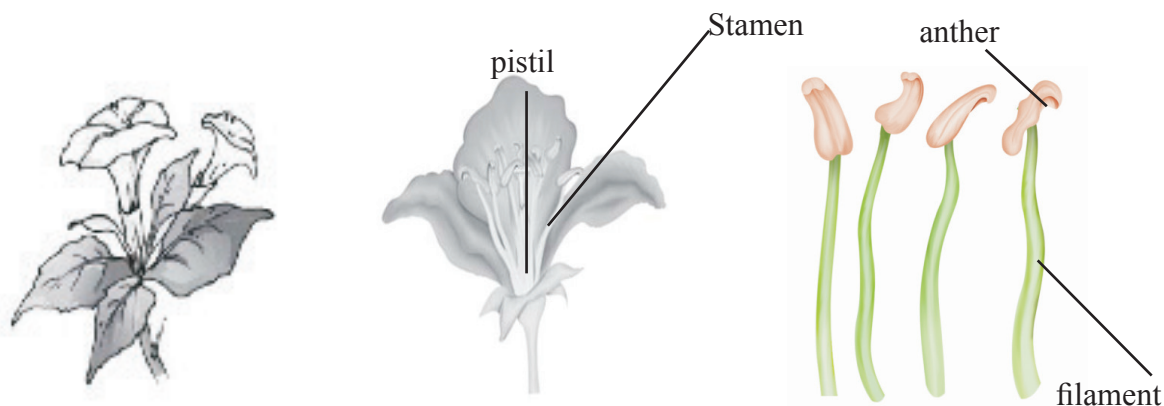

Fig 7.21 A bell shaped flower **Fig 7.22** Parts of a flower **Fig 7.23** Parts of a stamen

Look at Fig 7.23 carefully. It shows the different kinds of stamens present in different flowers. Can you recognise both the parts of the stamens in your flower? How many stamens are there in your flower? Draw one stamen and label its parts.

The innermost part of a flower is called the pistil. If you cannot see it completely, remove the remaining stamens. Identify the parts of the pistil with the help of Fig. 7.24.

Draw a neat, labelled diagram of the pistil of your flower.

Activity 11

Let us now study the structure of the ovary of a flower (Fig. 7.24). It is the lowermost and swollen part of the pistil. We will cut this part to study how it looks inside! Look at Fig. 7.25 (a)



and (b) carefully to understand how to cut the ovary of a flower.

Take two ovaries from different flowers. Cut them in two different ways as shown in Fig. 7.25. To prevent them from drying, put a drop of water on each of the two pieces of the ovary, you have cut.

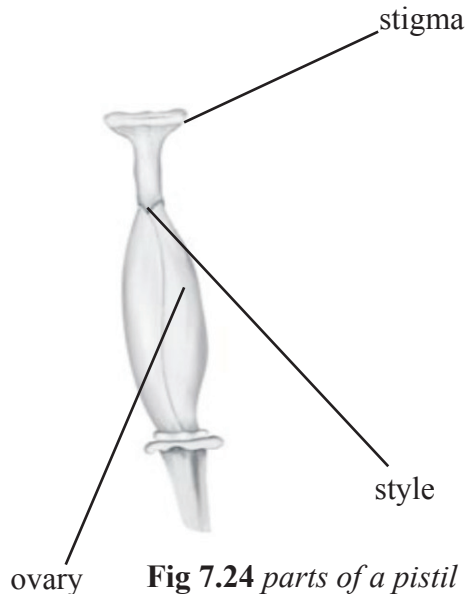

Fig 7.24 parts of a pistil

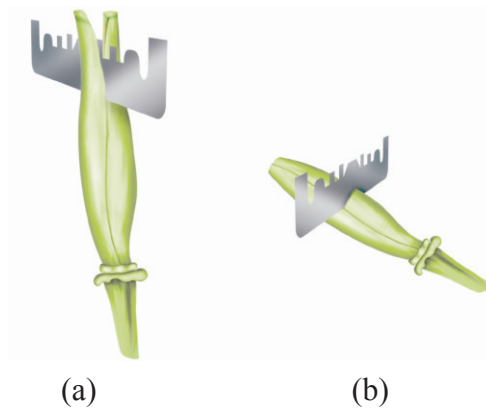

Fig 7.25 cutting an ovary (a) Longitudinal cut and (b) transverse cut

Observe the inner parts of the ovary using a lens (Fig. 7.26). Do you see some small bead like structures inside the ovary? They are called ovules. Draw and label the inner parts of the ovary in your notebook.

On your field trip, try to find out the names of as many flowers as you can by asking the gardener or any other person. Remember, not to pluck more flowers than you need. Based on what you have filled in Table 7.3, answer the following questions.

Do all flowers have sepals, petals, stamens and pistils? Are there flowers that do not have any of these? Are there flowers which have parts other than these?

Did you find any flowers which have sepals and petals that look similar?

Did you find any flowers in which the number of sepals is different from the number of petals?

Do you now agree that the structure of the flower is not always the same? The number of sepals, petals, stamens and pistils may also be different in different flowers. Sometimes, some of these parts may even be absent!

We have studied some features and functions of leaves, stems and roots. We studied the



Fig 7.26 Inner structure of an ovary (a) Longitudinal cut (b) transverse cut



structure of different flowers. We will learn about the function of flowers in higher classes. We will also learn about fruits in higher classes.

Plants are usually grouped into herbs, shrubs, trees, and climbers based on their height, stems and branches.

More to Know

- The largest flower-Rafflesia grows in Indonesia, nearly 1 meter in diameter.
- The smallest flower-Wolffia-only about 0.5mm in diameter.



What You have Learnt

- The stem bears leaves, flowers and fruits.
- A leaf usually has a petiole and a lamina.
- The pattern of veins on the leaf is called venation. It can be reticulate or parallel.
- Leaves give out water vapour through the process of transpiration.
- Green leaves make their food by the process of photosynthesis using carbon dioxide and water in the presence of sunlight.
- Roots absorb water and minerals from the soil and anchor the plant firmly in the soil.
- Roots are mainly of two types: tap root and fibrous roots.
- Plants having leaves with reticulate venation have tap roots while plants having leaves with parallel venation have fibrous roots.
- The stem conducts water from roots to the leaves (and other parts) and food from leaves to other parts of the plant.
- The parts of a flower are sepals, petals, stamens and pistil.



Exercises

1. Correct the following statements and rewrite them in your notebook.
 - (a) Stem absorbs water and minerals from the soil.
 - (b) Leaves hold the plant upright.



- (c) Roots conduct water to the leaves.
- (d) The number of petals and sepals in a flower is always equal.
- (e) If the sepals of a flower are joined together, its petals are also joined together.
- (f) If the petals of a flower are joined together, then the pistil is joined to the petal.
2. Draw (a) a leaf, (b) a taproot and (c) a flower, you have studied for Table 7.3.
3. Can you find a plant in your house or in your neighborhood, which has a long but a weak stem? Write its name. In which category would you classify it?
4. What is the function of a stem in a plant?
5. Which of the following leaves have reticulate venation?
Wheat, tulsi, maize, grass, coriander (dhanian), China rose
6. If a plant has fibrous root, what type of venation do its leaves likely to have?
7. If a plant has leaves with reticulate venation, what kind of roots will it have?
8. Is it possible for you to recognize the leaves without seeing them? How?
9. Write the names of the parts of a flower.
10. Which of the following plants have you seen? Of those that you have seen, which one have flowers?
Grass, maize, wheat, chilli, tomato, tulsi, pipal, shisham, banyan, mango, jamun, guava, pomegranate, papaya, banana, lemon, sugarcane, potato, groundnut
11. Name the part of the plant which produces its food. Name this process.
12. In which part of a flower, you are likely to find the ovary?
13. Name two flowers, each with joined and separated sepals.
- 14.
- a. Give the technical names of I. Baby root, II. Baby shoot.
- b. Name two roots modified for storage of food.
- c. Sweet potato is _____ and potato is a _____.
- d. What is a hermaphrodite flower?
15. Multiple choice Questions:
- a. Which of the following has a taproot?
- i. Maize
- ii. Wheat
- iii. Pea
- iv. Rice



- b. Which of the following is a modified stem?
 - i. Radish
 - ii. Onion
 - iii. Sweet potato
 - iv. maize
- c. Pollen grains are produced in
 - i. Flowers
 - ii. Ovary
 - iii. Anther
 - iv. fruit

SUGGESTED PROJECT AND ACTIVITIES

1. BECOME A LEAF EXPERT

Do this activity with a number of leaves over a period of a few weeks. For every leaf that you wish to study, pluck it and wrap it in a wet cloth and take it home. Now, put your leaf in a newspaper and place a heavy book on it. You can also put it under your mattress or a trunk! Take out the leaf after a week. Paste it on a paper and write a poem or story about it. With your leaf collection pasted in a book (a Herbarium), you can become quite an expert about leaves!

- 2. Names of plant parts are hidden in this grid. Search for them by going up, down, or even diagonally forward as well as backward. Have fun!

O	V	U	L	E	L	Y	T	S	T	E	M
V	E	I	N	W	Q	H	E	R	B	P	I
A	N	I	M	A	L	Z	E	X	R	N	D
R	F	I	L	A	M	E	N	T	M	U	R
Y	A	R	A	B	L	C	O	D	B	E	I
L	E	E	U	O	F	O	L	G	H	I	B
A	L	H	I	I	R	J	A	L	K	U	R
T	M	T	N	O	T	P	P	Q	R	R	A
E	E	N	S	T	U	F	E	H	V	W	N
P	Y	A	M	G	I	T	S	Z	Z	N	C
F	L	O	W	E	R	E	H	T	N	A	H
S	T	A	M	E	N	N	S	E	P	A	L



Body Movements

Keywords : Socket, Hinge, Snail, Stramline, Greek, X -rays

Sit absolutely still. Observe the movements taking place in your body. You must be blinking your eyes, time to time. Observe the movements in your body as you breathe. There are so many movements that happen in our bodies.

When you are writing in your notebook which part of the body are you moving? Or, when you turn and look at your friend? Different parts of your body move while you remain at the same place, in these examples. You also move from one place to another — you get up and go to your teacher or to the school compound, or go home after school. You walk, run, skip, jump and move from place to place.

Let us see how animals move from place to place by filling up Table 8.1, after discussing with our friends, teachers and parents.

Table 8.1 How do animals move from place to place

Animal	Body part used for moving from place to place	How does the animal move?
Cow	legs	walk
Humans		
Snake	Whole body	Slither
Bird		
Insect		
Fish		

Walk, run, fly, jump, creep, crawl, slither and swim – these are only a few of the ways in which animals move from one place to another. Why are there so many differences in the way that animals move from place to place? Why is it that many animals walk while a snake slithers or crawls and a fish swims?

Hey Children!

When you are born you have more than 300 hundred bones in your body. By the time you grow there are about 206 bones only. Why?

Yes, many of the infant's bones get joined together.



8.1 HUMAN BODY AND ITS MOVEMENTS

Let us look closely at some of our own movements to begin with, before looking at all these varieties of movements in animals.

Do you enjoy doing physical exercise at school? How do you move your hands and legs while doing different exercises? Let us try some of the many movements, our body is capable of.

Bowl an imaginary ball at an imaginary wicket. How did you move your arm? Did you rotate it at the shoulder in a circular movement? Did your shoulder also move? Lie down and rotate your leg at the hip. Bend your arm at the elbow and the leg at the knee. Stretch your arm sideways. Bend your arm to touch your shoulder with your fingers. Which part of your arm did you bend? Straighten your arm and try to bend it downwards. Are you able to do it?

Try to move the various parts of your body and record their movements in Table 8.2.

Table 8.2 Movements in our Body

Body Part	Movement				
	Rotates Completely	Rotates partly/turns	Bends	Lifts	Does not move at all
Neck		Yes			
Wrist					
Finger					
Knee					
Ankle					
Toe					
Back					
Head					
Elbow					
Arm	Yes				

Why is it that we are able to move a few parts of our body easily in various directions and some only in one direction? Why are we unable to move some parts at all?

Activity 1

Place a scale length-wise on your arm so that your elbow is in the centre (Fig. 8.1).

Ask your friend to tie the scale and your arm together. Now, try to bend your elbow. Are you able to do it?



Did you notice that we are able to bend or rotate our body in places where two parts of our body seem to be joined together — like elbow, shoulder or neck? These places are called joints. Can you name more such joints? If our body has no joints, do you think it would be possible for us to move in any way at all?

What exactly is joined together at these joints?

Press your fingers against the top of your head, face, neck, nose, ear, back of the shoulder, hands and legs including the fingers and toes.

Do you get a feel of something hard pressing against your fingers? The hard structures are the bones. Repeat this activity on other parts of your body. So many bones!

Bones cannot be bent. So, how do we bend our elbow? It is not one long bone from the upper arm to our wrist. It is different bones joined together at the elbow. Similarly, there are many bones present in each part of the body. We can bend or move our body only at those points where bones meet.

There are different types of joints in our body to help us carry out different movements and activities. Let us learn about some of them.

Ball and socket joints

Activity 2

Roll a strip of paper into a cylinder. Make a small hole in an old rubber or plastic ball (under supervision) and push the paper cylinder into it as shown in Fig. 8.2. You can also stick the cylinder on the ball. Put the ball in a small bowl. Does the ball rotate freely inside the bowl? Does the paper cylinder also rotate?

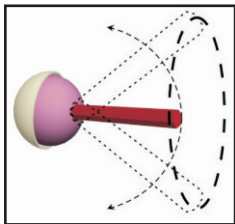

Fig 8.2 Making a ball and socket joint

movements we tried at the beginning of this section?

Now, imagine that the paper cylinder is your arm and the ball is its end. The bowl is like the part of the shoulder to which your arm is joined. The rounded end of one bone fits into the cavity (hollow space) of the other bone (Fig.8.3). Such a joint allows movements in all directions. Can you name another such joint you can think of, recollecting the body

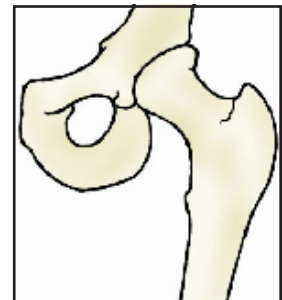

Fig 8.3 A ball and socket joint

Pivotal Joint

The joint where our neck joins the head is a pivotal joint. It allows us to bend our head forward and backward and turn the head to our right or left. Try these movements. How are these movements different from those of our arm that can rotate a complete circle in its ball and socket

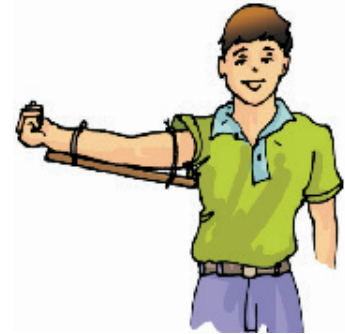

Fig 8.1 Can you bend your arm now



joint? In a pivotal joint a cylindrical bone rotates in a ring.

Hinge joints

Open and close a door a few times. Observe the hinges of the door carefully. They allow the door to move back and forth.

Activity 3

Let us look at the kind of movement allowed by a hinge. Make a cylinder with cardboard or thick chart paper, as shown in Fig. 8.4. Attach a small pencil to the cylinder by piercing the cylinder at the centre, as shown. Make a hollow half cylinder from cardboard such that the rolled

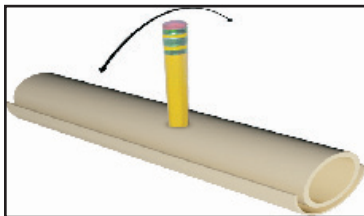

Fig 8.4 Directions of movement allowed by a hinge like joint

up cylinder can fit inside it easily. The hollow half cylinder with the rolled up cylinder sitting inside it, allows movement like a hinge. Try to move the rolled up cylinder. How does it move? How is this movement different from what we saw with our constructed ball and socket joint? We saw this kind of movement at the elbow in Activity 1.

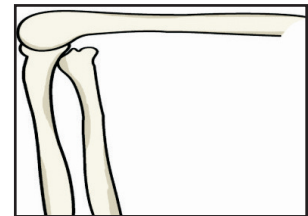

Fig 8.5 Hinge joints of the Knee

What we have constructed in Fig. 8.4 is different from a hinge, of course. But, it illustrates the direction in which a hinge allows movement. The elbow has a hinge joint that allows only a back and forth movement (Fig. 8.5). Can you think of more examples of such joints?

Fixed joints

Some joints between bones in our head are different from those we have discussed so far. The bones cannot move at these joints. Such joints are called fixed joints. When you open your mouth wide, you can move your lower jaw away from your head, isn't it? Try to move your upper jaw, now. Are you able to move it? There is a joint between the upper jaw and the rest of the head which is a fixed joint. We discussed only some of the joints that connect parts of our body. What gives the different parts of the body their different shapes?

If you wanted to make a doll, what will you make first? Perhaps a framework to give the doll shape before making its outer structure, isn't it? All the bones in our body also form a framework to give a shape to our body. This framework is called the skeleton (Fig. 8.6.)

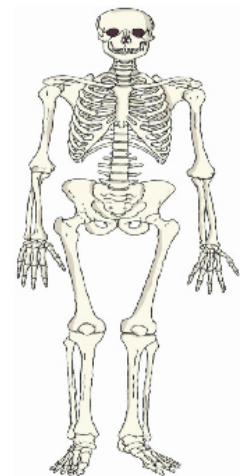

Fig 8.6 The Human Skeleton

How do we know that this is the shape of a human skeleton? How do we know the shapes of the different bones in our body? We can have some idea about the shape and number of bones in some parts of our body by feeling them. One way we could know this shape better would be to look at X-ray images of the human body.



Did you or anyone in your family ever have an X-ray of any part of your body taken? Sometimes when we are hurt, or have an accident, doctors use these X-ray images to find out about any possible injuries that might have happened to the bones. The X-rays show the shapes of the bones in our bodies.

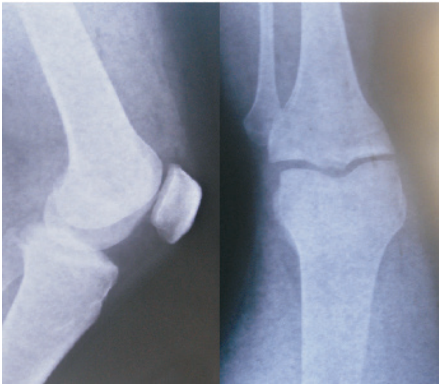

Fig 8.7 X-ray of ankle and knee Joints

Feel the bones in your forearm, upper arm, lower leg and upper leg. Try to find the number of bones in each part. Similarly, feel the bones of your ankle and knee joints and compare these with the X-ray images (Fig. 8.7).

Bend your fingers. Are you able to bend them at every joint? How many bones does your middle finger have? Feel the back of your palm. It seems to have many bones, isn't it (Fig. 8.8) ? Is your wrist



Fig 8.8 Bones of the hand

flexible? It is made up of several small bones. What will happen if it has only one bone?

Activity 4

Take a deep breathe and hold it for a little while. Feel your chest bones and the back bone by gently pressing the middle of the chest and back at the same time. Count as many ribs (bones of the chest) as possible. Observe Fig. 8.9 carefully and compare with what you feel of the chest bones. We see that the ribs are curiously bent. They join the chest bone and the backbone together to form a box. This is called the rib cage. Some important internal parts of our body lie protected inside this cage.

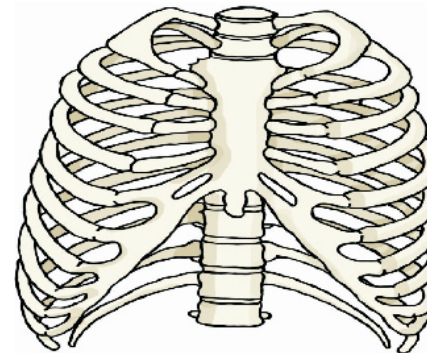

Fig 8.9 The rib cage

Ask some friends to touch their toes without bending their knees. Starting from the neck, move your fingers downwards on the back of your friend. What you feel is the backbone. It is made of many small bones (Fig. 8.10). The rib cage is joined to these bones.

If backbone was made up of only one long bone, will your friend be able to bend?

Make your friend stand with a hand pressed to the wall and try to push it. Do you notice two bones standing where the shoulders are? They are called shoulder bones (Fig 8.11).

Observe Fig. 8.12 carefully. This structure is made of pelvic bones. They enclose the portion of your body below the stomach. This is the part you sit on.

The skull is made of many bones joined together (Fig. 8.13). It encloses and protects a very important part of the body, the brain. We discussed many bones and the joints of our skeleton.



There are some additional parts of the skeleton that are not as hard as the bones and which can be bent. These are called cartilage.

Feel your ear. Do you find any hard bony parts that can be bent (Fig. 8.14)? There do not seem to be any bones here, isn't it? Do you notice anything different between the ear lobe and the portions above it (Fig. 8.15), as you press them between your fingers? You do feel something in the upper parts of the ear that is not as soft as the ear lobe but, not as hard as a bone, isn't it? This is cartilage. Cartilage is also found in the joints of the body.



Fig 8.10 *The back bone*

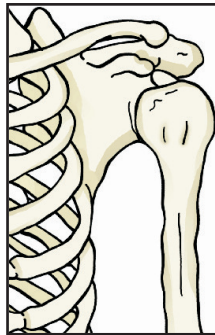

Fig 8.11 *Shoulder bones*

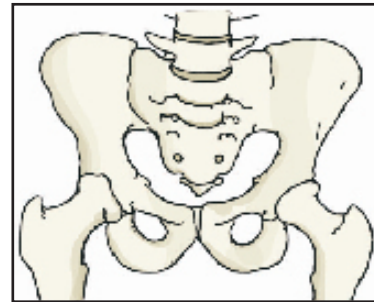

Fig 8.12 *Pelvic bones*

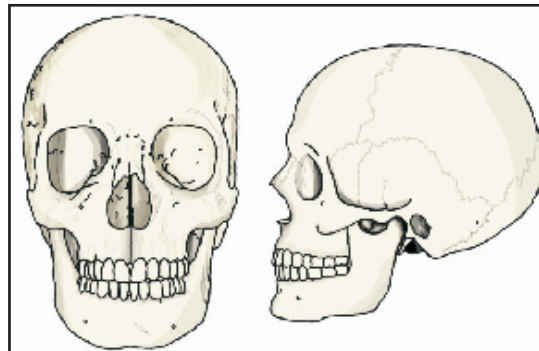

Fig 8.13 *The skull*

We have seen that our skeleton is made up of many bones, joints and cartilage. You could feel, bend and move many of them. Draw a neat figure of the skeleton in your notebook.

We have learnt about the bones in our body and about joints that help us move in different ways. What makes the bones move the way they do? Let us find out.

Make a fist with one hand, bend your arm at the elbow and touch your shoulder with the thumb (Fig. 8.16). Do you see any change in your upper arm? Touch it with the other hand. Do you feel a swollen region inside your upper arm? This is a muscle. The muscle bulged due to contraction (it became smaller in length). Now bring your arm back to its normal position. What happened to the muscle? Is it still contracted? You can observe similar contraction of muscles in your leg when you walk or run.



When contracted, the muscle becomes shorter, stiffer and thicker. It pulls the bone.

Muscles work in pairs. When one of them contracts, the bone is pulled in that direction. The other muscle of the pair relaxes. To move the bone in the opposite direction, the relaxed muscle contracts to pull the bone towards its original position, while the first relaxes. A muscle can only pull. It cannot push. Thus, two muscles have to work together to move a bone. (Fig. 8.16)



Fig 8.14 Upper part of ear has cartilage

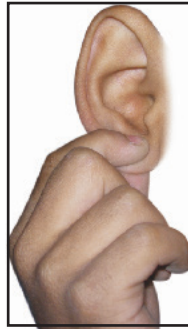

Fig 8.15 The ear lobe

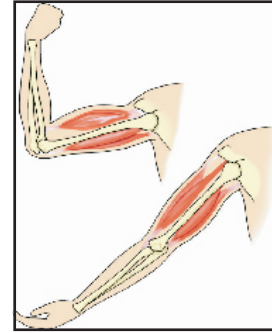

Fig 8.16 Two muscles work together to form a bone

Are muscles and bones always required for movement? How do other animals move? Do all animals have bones? What about an earthworm or a snail? Let us study the manner of movement, that is, the gait of some animals.

8.2 “GAIT OF ANIMALS”

Earthworm

Activity 5

Observe an earthworm moving on soil in a garden. Gently lift it and place it on a piece of blotting or filter paper. Observe its movement (Fig. 8.17). Then place it on a smooth glass plate or any slippery surface. Observe its movement now. Is it different from that on paper? In which of the above two surfaces do you find that the earthworm is able to move easily?

The body of an earthworm is made up of many rings joined end to end. An earthworm does not have bones. It has muscles which help to extend and shorten the body. During movement, the earthworm first extends the front part of the body, keeping the rear portion fixed to the ground. Then it fixes the front end and releases the rear end. It then shortens the body and pulls the rear end forward. This makes it move forward by a small distance. Repeating such muscle expansions and contractions, the earthworm can move through soil. Its body secretes a slimy substance to help the movement.



Fig 8.17 Movement of earthworm



How does it fix parts of its body to the ground? Under its body, it has a large number of tiny bristles (hair like structures) projecting out. The bristles are connected with muscles. The bristles help to get a good grip on the ground.

The earthworm, actually, eats its way through the soil! Its body then throws away the undigested part of the material that it eats. This activity of an earthworm makes the soil more useful for plants.

Snail

Activity 6

Collect a snail from a garden. Have you seen the rounded structure it carries on its back (Fig. 8.18)? This is called the shell and it is the outer skeleton of the snail, but is not made of bones. The shell is a single unit and does not help in moving from place to place. It has to be dragged along.



Fig 8.18 A snail

Place the snail on a glass plate and watch it. When it starts moving, carefully lift the glass plate along with the snail over your head. Observe its movements from beneath.

A thick structure and the head of the snail may come out of an opening in the shell. The thick structure is its foot, made of strong muscles. Now, carefully tilt the glass plate. The wavy motion of the foot can be seen. Is the movement of a snail slow or fast as compared to an earthworm?

Cockroach

Activity 7

Observe a cockroach (Fig. 8.19).

Cockroaches walk and climb as well as fly in the air. They have three pairs of legs. These help in walking. The body is covered with a hard outer skeleton. This outer skeleton is made of different units joined together and that permits movement.



Fig 8.19 A Cockroach

There are two pairs of wings attached to the breast. The cockroaches have distinct muscles — those near the legs move the legs for walking. The breast muscles move the wings when the cockroach flies.

Birds

Birds fly in the air and walk on the ground. Some birds like ducks and swans also swim in water. The birds can fly because their bodies are well suited for flying. Their bones are hollow and light. The bones of the hind limbs are typical for walking and perching. The bony parts of the forelimbs are modified as wings. The shoulder bones are strong. The breastbones are modified to hold

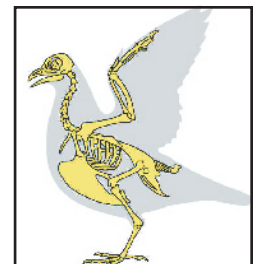

Fig 8.20 Skelton of a bird



muscles of flight which are used to move the wings up and down (Fig. 8.20).

Fish

Activity 8

Make a paper boat. Put it in water and push it with one narrow end pointing forward [Fig. 8.21 (a)]. Did it go into the water easily? Now hold the boat sideways and push it into the water from the broad side [Fig. 8.21 (b)]. Are you able to make the boat move in water when you push it from this side?

Have you noticed that the shape of a boat is somewhat like a fish (Fig 8.22)? The head and tail of the fish are smaller than the middle portion of the body – the body tapers at both ends. This body shape is called streamlined.

The shape is such that water can flow around it easily and allow the fish to move in water. The skeleton of the fish is covered with strong muscles. During swimming, muscles make the front part of the body curve to one side and the tail part swings towards the opposite side. The fish forms a curve as shown in Fig. 8.23. Then, quickly, the body and tail curve to the other side. This makes a jerk and pushes the body forward. A series of such jerks make the fish swim ahead. This is helped by the fins of the tail.

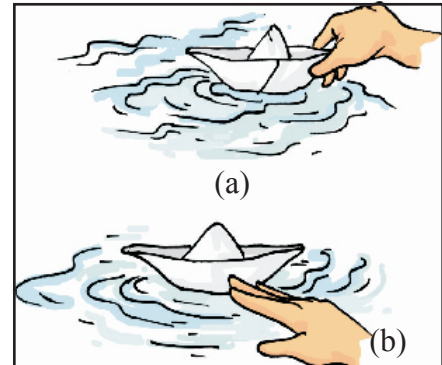

Fig 8.21 *Playing with boats*

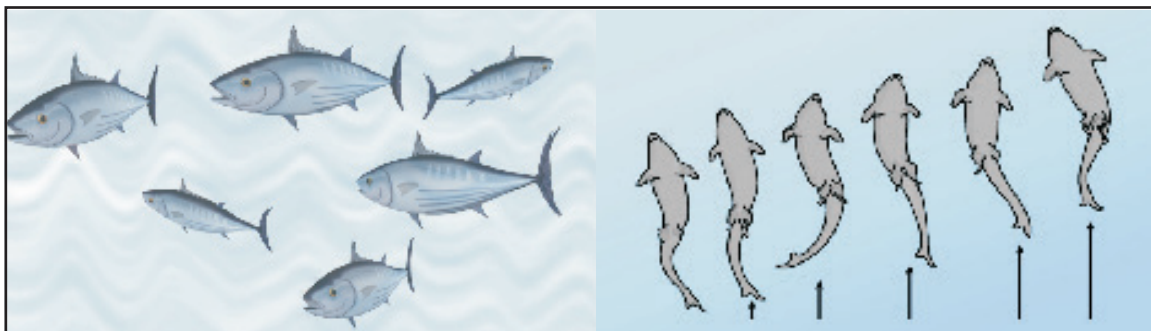

Fig 8.22 *Fish*

Fig 8.23 *Movement in fish*

Fish also have other fins on their body which mainly help to keep the balance of the body and to keep direction, while swimming. Did you ever notice that under water divers wear fin like flippers on their feet, to help them move easily in water?

How do snakes move?

Have you seen a snake slither? Does it move straight (Fig. 8.24)? Snakes have a long backbone. They have many thin muscles. They are connected to each other even though they are far from one another. Muscles also interconnect the backbone, ribs and skin.



The snake's body curves into many loops. Each loop of the snake gives it a forward push by pressing against the ground. Since its long body makes many loops and each loop gives it this push, the snake moves forward very fast and not in a straightline.

We have learned about the use of bones and muscles for the movements of different animals. You must be having many unanswered questions buzzing in your minds about the different movements in animals? The ancient Greek philosopher Aristotle, in his book *Gait of Animals*, asked himself these questions. Why do different animals have the body parts that they do have and how do these body parts help animals to move the way they do? What are the similarities and differences in these body parts between different animals? How many body parts are needed by different animals for moving from place to place? Why two legs for humans and four for cows and buffaloes? Many animals seem to be having an even number of legs, why? Why is the bending of our legs different from that of our arms?

So many questions and perhaps we have looked for some answers through our activities in this chapter and we need to look for many more answers.



Fig 8.24 *Movement in snake*



What You have Learnt

- Bones and cartilage form the skeleton of the human body. It gives the frame and shape to the body and helps in movement. It protects the inner organs.
- The human skeleton comprises the skull, the back bone, ribs and the breast bone, shoulder and hipbones, and the bones of hands and legs.
- The bones are moved by alternate contractions and relaxations of two sets of muscles.
- The bone joints are of various kinds depending on the nature of joints and direction of movement they allow.
- Strong muscles and light bones work together to help the birds fly. They fly by flapping their wings.
- Fish swim by forming loops alternately on two sides of the body.
- Snakes slither on the ground by looping sideways. A large number of bones and associated muscles push the body forward.
- The body and legs of cockroaches have hard coverings forming an outer skeleton.



- The muscles of the breast connected with three pairs of legs and two pairs of wings help the cockroach to walk and fly.
- Earthworms move by alternate extension and contraction of the body using muscles. Tiny bristles on the underside of the body help in gripping the ground.
- Snails move with the help of a muscular foot.



Exercises

1. Fill in the blanks

- Joints of the bones help in the _____ of the body.
- A combination of bones and cartilages forms the _____ of the body.
- The bones of the elbow are joined by _____ joint.
- The contraction of the _____ pulls the bones during movement.
- An adult human has _____ bones where as a baby has more than _____ bones.
- In water birds, _____, _____ present help them to swim.
- Amoeba moves with the help of _____

2. Indicate True(T) and False (F) among the following sentences

- The movement and locomotion of all animals is exactly the same. ()
- The cartilages are harder than bones. ()
- The finger bones do not have joints ()
- The arm has two bone. ()
- Cockroach have an outer Skelton. ()

3. Match the items in the column I with one or more items of Column II

Column I

Upper Jaw

Fish

Ribs

Snail

Cockroach

Column II

Have fins on the body

has an outer skeleton

can fly in the air

is an immovable joint

Protects the heart

Shows very slow movement

Have a streamlined body



4. Answer the following:
 - a. What is a ball and socket joint?
 - b. Which of the skull bones are movable?
 - c. Why can our elbow not move backwards?
 - d. How many vertebrae join to form the vertebral column in a human being?
 - e. What are the floating ribs?
5. What kind of movements are seen in
 - a. earthworm
 - b. snail
 - c. cockroach
 - d. snake
 - e. birds

THINGS TO THINK ABOUT

- We discussed the many movements our bodies are capable of. Healthy bones, muscles, joints and cartilages are needed by the body for all these movements. Some of us suffer from conditions that could make these movements not so easy. In a whole class activity, try to find ways that one would manage everyday activities, if any one of our body movements was not possible. In Activity 1, for instance, you tied a scale on your arm and disabled the elbow movement. Think of other ways of restricting normal body movements and find ways that everyday activities could then be managed.





The living Organisms and Their Surroundings

Keywords : Desert, Habitat, Adaptation, Grassland, Stimuli, Excretion, Reproduction

Let us recollect your ideas and remember the objects during a picnic or a trip you have seen. You might have come across a river or a pond, a forest or a mountain. You might have seen many trees, on the mountains; pines and deodars, very different from the one's near your home on the plains. You might have come across a river or a pond and seen many objects, animals quite different from your locality. And you would be wonder struck on seeing the different places, some cold places and some hot places and animals and plants of various kinds.

You would be surprised to note that every part of Earth has one or other type of organisms. You will find living creatures even in the cupboards of your home and learn that tiny living organisms are found even in the openings of volcanoes and the coldest arctic regions of the Earth. So you conclude that living organisms of one locality are entirely different from other locality.

What about the surroundings in these different regions? Were they the same.

Paheli and Boojho went on vacation to many places of interest. One such trip took them to the river Ganga in Rishikesh. They climbed the mountains of the Himalayas, where it was very cold. They saw many kinds of trees on these mountains — oaks, pines and deodars, very different from the ones near their home on the plains! In yet another trip, they travelled to Rajasthan and moved on camels through the hot desert. They collected different kinds of cactus plants from this trip. Finally, they went on a trip to Puri and visited the sea beach, dotted with casuarina trees. While recollecting all the fun that they had on these trips, a thought struck them. All these places were so different from one another, some were cold, some very hot and dry, and some places so humid. And yet all of them had many organisms (living creatures) of various kinds.

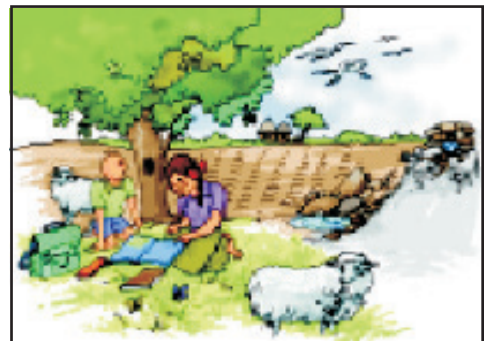

Fig 9.1 Search for living organisms

They tried to think of a place on Earth where there may not be any living creatures. Boojho thought of places near his home. Inside the house, he tried the cupboards. He had thought that there may not be any living organisms here, but he found one tiny spider in the cupboard. Outside the home too, there did not seem to be any place, he could think of, that did not have living creatures of some kind or the other (Fig. 9.1). Paheli started thinking and reading about far away places. She read that people have even found tiny living organisms in the openings of volcanoes!

9.1 ORGANISMS AND THE SURROUNDINGS WHERE THEY LIVE

Another thought that occurred to Paheli and Boojho was about the kinds of living organisms that were present in different locations that they had visited. The deserts had camels, the mountains



had goats and yak. Puri had some other creatures crabs on the beach and such a variety of fish being caught by the fishermen at the sea! And then, there did seem to be some creatures like ants that were present in all these different locations. The kinds of plants found in each of these regions were so different from the plants of the other regions.?

Activity 1

Let us start with a forest. Think of all the plants, animals and objects that can be found there. List them in Column 1 of Table 9.1. List things, animals and plants, found in the other regions that are also shown in the table. You can collect the examples scattered through this chapter to fill Table 9.1. Discuss also with your friends, parents and teachers, to find more examples to fill the tables. You can also consult many interesting books in libraries that talk of animals, plants and minerals of different regions.

Try and include many plants, animals and objects, big and small, in each of the columns in this table. What kind of objects will we find that may not be animals or plants? Perhaps parts of plants like dried leaves, or parts of animals, like bones. We may also find different kinds of soils and pebbles. Water in the oceans may have salts dissolved in it as discussed in Chapter 5. There could be many more objects.

As we go through the chapter, keep adding more examples to Table 9.1. We will discuss the table as we travel through many more interesting places.

Table 9.1 Animals Plants and other objects found in different surroundings

In the forest	On mountains	In the desert	In the sea	Any other

9.2 HABITAT AND ADAPTATION

What do you find from the plants and animals listed in Activity 1? Did you find a large variety in them? Look at what you have entered in the column for the desert and the column for the sea in Table 9.1. Did you list very different kind of organisms in these two columns?

What are the surroundings like, in these two regions?

In the sea, plants and animals are surrounded by saline (salty) water. Most of them use the air dissolved in water.

There is very little water available in the desert. It is very hot in the day time and very cold at night in the desert. The animals and plants of the desert live on the desert soil and breathe air from the surroundings.

The sea and the desert are very different surroundings and we find very different kind of



plants and animals in these two regions, isn't it? Let us look at two very different kind of organisms from the desert and the sea – a camel and a fish. The body structure of a camel helps it to survive in desert conditions. Camels have long legs which help to keep their bodies away from the heat of the sand (Fig. 9.2). They excrete small amount of urine, their dung is dry and they do not sweat. Since camels lose very little water from their bodies, they can live for many days without water.



Fig 9.2 *Camels in their surroundings*

We see that the features of a fish help it to live inside water and the features of a camel help it to survive in a desert.

We have taken only two examples from a very wide variety of animals and plants that live on the Earth. In all this variety of organisms, we will find that they have certain features that help them live in the surroundings in which they are normally found. The presence of specific features or certain habits, which enable a plant or an animal to live in its surroundings, is called adaptation. Different animals are adapted to their surroundings in different ways.

The surroundings where organisms live is called a habitat. The organisms depend for their food, water, air, shelter and other needs on their habitat. Habitat means a dwelling place (a home). Several kinds of plants and animals may share the same habitat.

DO YOU KNOW

There are some changes that can happen in an organism over a short period of time to help them adjust to some changes in their surroundings. For instance, if we live in the plains and suddenly go to high mountain regions, we may experience difficulty in breathing and doing physical exercise for some days. We need to breathe faster when we are on high mountains. After some days, our body adjusts to the changed conditions on the high mountain. Such small changes that take place in the body of a single organism over short periods, to overcome small problems due to changes in

Let us look at different kinds of fish. Some of these are shown in Fig. 9.3. There are so many kinds of fish, but, do you see that they all have something common about their shape? All the ones shown here have the streamlined shape that was discussed in Chapter 8. This shape helps them move inside water. Fish have slippery scales on their bodies. These scales protect the fish and also help in easy movement through water. We discussed in Chapter 8, that fish have flat fins and tails that help them to change directions and keep their body balance in water. Gills present in the fish help them to use oxygen dissolved in water.



Fig 9.3 *Different kinds of fish*



the surroundings, are called acclimatisation. These changes are different from the adaptations that take place over thousands of years.

The plants and animals that live on land are said to live in terrestrial habitats. Some examples of terrestrial habitats are forests, grasslands, deserts, coastal and mountain regions. On the other hand, the habitats of plants and animals that live in water are called aquatic habitats. Ponds, swamps, lakes, rivers and oceans are some examples of aquatic habitats. There are large variations in forests, grasslands, deserts, coastal and mountain regions located in different parts of the world. This is true for all aquatic habitats as well.

The living things such as plants and animals, in a habitat, are its biotic components. Various non-living things such as rocks, soil, air and water in the habitat constitute its abiotic components. Sunlight and heat also form abiotic components of the habitat.

We know that some plants grow from seeds. Let us look at some abiotic factors and their effect on seeds as they grow into young plants.

Activity 2

Recall Activity 5 in Chapter 1 — we made sprouts from moong and chana seeds. When the seed turned into a sprout, it germinated. This was the beginning of a new plant, from the seed.

Collect some dry moong seeds. Keep a small heap of seeds aside and soak the rest in water for a day. Divide the soaked seeds into four parts. Keep one part completely submerged in water for 3-4 days. Do not disturb the dry seeds and those submerged in water. Keep one part of soaked seeds in a sunny room and another in a completely dark region like a cupboard that does not allow any light to come in. Keep the last part in very cold surroundings, say, in a refrigerator or with ice around them. Set these three parts to germinate by rinsing them and draining the water every day. What do you notice, after a few days? Do the seeds in all the five parts germinate equally? Do you find slower or no germination in any of these?

Do you find that abiotic factors like air, water, light and heat are very important for growth of plants. In fact, these abiotic factors are important for all living organisms.

We find that organisms exist in very cold as well as very hot climates and surroundings, isn't it? How do they manage to survive? That is where, adaptation comes in.

Adaptation does not take place in a short time. Over thousands of years, the abiotic factors of a region change. Those animals which cannot adapt to these changes die out, and only the adapted ones survive. Animals adapt to different abiotic factors in different ways. The result is variety of organisms present in different habitats.

Let us look at some habitats, the abiotic factors of these, and the adaptations of animals to these habitats.



9.3 A JOURNEY THROUGH DIFFERENT HABITATS

Some Terrestrial Habitats

Deserts

We discussed the abiotic factors of a desert and the adaptations in camels to these. What about other animals and plants that are found in deserts? Do they have the same kind of adaptations?

There are desert animals like rats and snakes, which do not have the long legs that the camel has. To stay away from the intense heat during the day, they stay in burrows deep in the sand (Fig 9.4). These animals come out only during the night, when it is cooler.

Fig. 9.5 shows some typical plants that grow in a desert. How are these adapted to the desert?



Fig 9.4 Desert animals in burrows

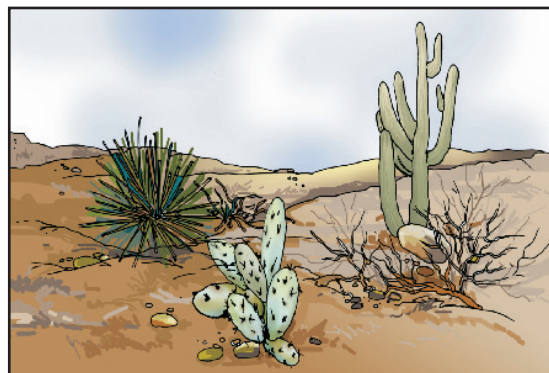

Fig 9.5 Some typical plants that grows in desert

Activity 3

Bring a potted cactus and a leafy plant to the classroom. Tie polythene bags to some parts of the two plants, as was done for Activity 4 in Chapter 7, where we studied transpiration in plants.

Leave the potted plants in the sun and observe after a few hours. What do you see? Do you notice any difference in the amount of water collected on the two polythene bags?

Desert plants lose very little water through transpiration. The leaves in desert plants are either absent, very small, or they are present in the shape of spines. This helps in reducing loss of water from the leaves through transpiration. The leaf-like structure you see in a cactus is, in fact, its stem (Fig. 9.5). Photosynthesis in these plants is usually carried out by the stems. The stem is also covered with a thick waxy layer, which helps to retain water. Most desert plants have roots that go very deep into the soil for absorbing water.

Mountain regions

These habitats are normally very cold and windy. In some areas, snowfall may take place in winters.



There is a large variety of plants and animals living in the mountain regions. Have you seen the kind of trees shown in Fig. 9.6?

If you live in a mountain region or have visited one, you may have seen a large number of such trees. But, have you ever noticed such trees naturally growing in other regions?

How are these trees adapted to the conditions prevailing in their habitat? These trees are normally cone shaped and have sloping branches. The leaves of some of these trees are needle-like. This helps the rainwater and snow to slide off easily. There could be trees with shapes very different from these that are also present on mountains. They may have different kind of adaptations to survive on the mountains.

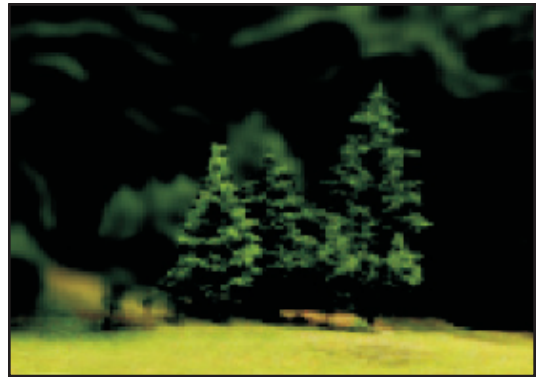

Fig 9.6 Trees of mountain habitat

Animals living in the mountain regions are also adapted to the conditions there (Fig. 9.7). They have thick skin or fur to protect them from cold. For example, yaks have long hair to keep them warm. Snow leopard has thick fur on its body including feet and toes. This protects its feet from the cold when it walks on the snow. The mountain goat has strong hooves for running up the rocky slopes of the mountains.



(a)

(b)

(c)

Fig 9.7 (a) Snow leopard (b) Yak and (c) mountain goat are adapted to mountain habitats

As we go up in the mountainous regions, the surroundings change and we see different kinds of adaptations at different heights.

Grasslands

A lion lives in a forest or a grassland and is a strong animal that can hunt and kill animals like deer. It is light brown in colour. Look at the picture of a lion and that of a deer (Fig. 9.8). How are the eyes placed in the face for these two animals? Are they in the front or on the side of the face? Lions have long claws in their front legs that can be withdrawn inside the toes. Do the features of a lion help it in any way to survive? It's light brown colour helps it to hide in dry grasslands when



it hunts for prey (animals to eat). The eyes in front of the face allow it to have a correct idea about the location of its prey.



(a)



(b)

Fig 9.8 (a) Lion and (b) deer

A deer is another animal that lives in forests and grasslands. It has strong teeth for chewing hard plant stems of the forest. A deer needs to know about the presence of predators (animals like lion that make it their prey) in order to run away from them and not become their prey. It has long ears to hear movements of predators. The eyes on the side of its head allow it to look in all directions for danger. The speed of the deer helps them to run away from the predators.

There are many other features of a lion, a deer or other animals and plants that help them to survive in their habitat.

Some Aquatic Habitats

Oceans

We already discussed how fish are adapted to live in the sea. Many other sea animals have streamlined bodies to help them move easily in water. There are some sea animals like squids and octopus, which do not have this streamlined shape. They stay deeper in the ocean, near the seabed and catch any prey that moves towards them. However, when they move in water they make their body shapes streamlined. These animals have gills to help them use oxygen dissolved in water.

There are some sea animals like dolphins and whales that do not have gills. They breathe in air through nostrils or blowholes that are located on the upper parts of their heads. This allows them to breathe in air when they swim near the surface of water. They can stay inside the water for a long time without breathing. They come out to the surface from time to time, to breathe in air. Did you ever see this interesting activity of dolphins in television programme or films on ocean life?

Ponds and lakes

Have you seen plants growing in ponds, lakes, rivers and even some drains? Go on a field



trip to a nearby pond, if possible, and try to draw the kinds of plants that are seen there. How are the leaves, stems and roots of these plants placed?

Some of these plants have their roots fixed in the soil below the water

(Fig. 9.9). In terrestrial plants, roots normally play a very important role in the absorption of nutrients and water from the soil. However, in aquatic plants, roots are much reduced in size and their main function is to hold the plant in place.

The stems of these plants are long, hollow and light. The stems grow up to the surface of water while the leaves and flowers, float on the surface of the water.

Some aquatic plants are totally submerged in water. All parts of such plants grow under water. Some of these plants have narrow and thin ribbon-like leaves. These can bend in the flowing water. In some submerged plants, leaves are often highly divided, through which the water can easily flow without damaging them.

Frogs usually have ponds as their habitat. Frogs can stay both inside the pond water as well as move on land. They have strong back legs that help them in leaping and catching their prey. They have webbed feet which help them swim in water.

We have discussed only a few common animals and plants compared to the wide variety that live in the different habitats. You may have also noticed the very wide variety in plants around you, when you prepared a herbarium as part of the suggested activities in Chapter 7. Imagine the kind of variety that you could see in a herbarium of leaves of plants from all regions of the Earth!

9.4 CHARACTERISTICS OF THE LIVING BEINGS

We went on a journey through different habitats and discussed many plants and animals. In Activity 1, we listed objects, plants and animals found in different surroundings. Suppose we stop a while and think which examples in our list are living? Let us think of examples from a forest. Trees, creepers, small and big animals, birds, snakes, insects, rocks, soil, water, air, dry leaves, dead animals, mushrooms and moss may be only some of the objects that are present in the forest. Which of these are living? Think of objects that you can see around you at this moment and group them as living and non-living. In some cases, it is easy for us to know. For example, objects like chair or a table in our homes we know that they are not alive.

A chair, table, stone or a coin. We know that they are not alive. Similarly, we do know that we are alive and so are all the people of the world. We also see animals around us that are so full

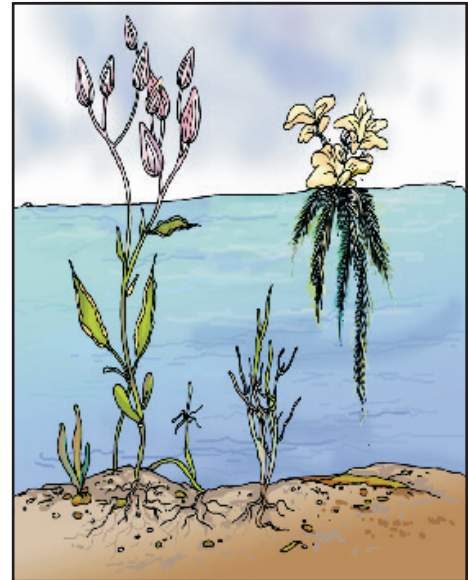

Fig 9.9 *Some aquatic plants float on water. Some have their roots fixed in the soil at the bottom. Some aquatic plants are completely submerged in water.*



of life — dogs, cats, monkeys, squirrels, insects and many others.

How do we know that something is living? Often, it is not so easy to decide. We are told that plants are living things, but they do not appear to move like a dog or a pigeon. On the other hand, a car or a bus can move, still we consider them as non-living. Plants and animals appear to grow in size with time. But then, at times, clouds in the sky also seem to grow in size. Does it mean that clouds are living? No! So, how does one distinguish between living and non-living things? Do living things have some common characteristics that make them very different from the non-living?

You are a wonderful example of a living being. What characteristics do you have which make you different from a non-living thing? List a few of these characteristics in your notebook. Look at your list and mark those characteristics that you have listed, which may also be found in animals or plants.

Some of these characteristics are perhaps common to all living things.

Do all living things need food?

In Chapters 1 and 2, we learnt that all living things need food and how essential it is to animals and to us. We have also learnt that plants make their own food through the process of photosynthesis. Animals depend on plants and other animals for their food.

Food gives organisms the energy needed for them to grow. Organisms also need this energy for other life processes that go on inside them.

Do all living things show growth?

Does the kurta you had four years back, still fit you? You cannot wear it any more, isn't



Fig 9.10 A baby grows into a adult
hen or a cock. (Fig 9.11).

it? You must have grown taller during these years. You may not realise it, but you are growing all the time and in few more years you will become an adult. (Fig 9.10).

Young ones of animals also grow into adults. You would surely have noticed pups of a dog grow into adults. A chicken hatched from an egg, grows into a

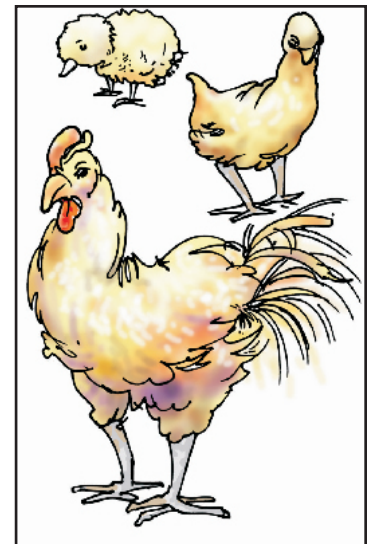

Fig 9.11 A chicken grows in to an adult

Plants also grow. Look around you and see a few plants of a particular type. Some are very small and young, some are grown.



They may all be in different stages of growth. Look at the plants after a few days and weeks. You may find that some of them have grown in size. Growth seems to be common to all living things.

Do you think, non-living things cannot show growth?

Do all living things respire?

Can we live without breathing? When we inhale, the air moves from outside to the inside of the body. When we breathe out, the air moves from inside our body to outside. Breathing is part of a process called respiration. In respiration, some of the oxygen of the air we breathe in, is used by the living body. We breathe out the carbon dioxide produced in this process.

The process of breathing in animals like cows, buffaloes, dogs or cats is similar to humans. Observe any one of these animals while they are taking rest, and notice the movement of their abdomen. This slow movement indicates that they are breathing.

Respiration is necessary for all living organisms. It is through respiration that the body finally obtains energy from the food it takes.

Some animals may have different mechanisms for the exchange of gases, which is a part of the respiration process. For example, earthworms breathe through their skin. Fish, we have learnt, have gills for using oxygen dissolved in water. The gills absorb oxygen from the air dissolved in water.

Do plants also respire? Exchange of gases in plants mainly takes place through their leaves. The leaves take in air through tiny pores in them and use the oxygen. They give out carbon dioxide to the air.

We learnt that in sunlight, plants use carbon dioxide of air to produce their own food and give out oxygen. Plants produce their food only during the daytime whereas respiration in them takes place day and night. The amount of oxygen released in the process of food preparation by plants is much more than the oxygen they use in respiration.

Do all living things respond to stimuli?

How do you respond, if you suddenly step on a sharp object like a thorn, while walking barefoot? How do you feel when you see or think about your favourite food? You suddenly move from a dark place into bright sunlight. What happens? Your eyes shut themselves automatically for a moment till they adjust to the changed bright surroundings. Your favourite food, bright light and a thorn, in the above situations are some examples of changes in your surroundings. All of us respond immediately to such changes. Changes in our surroundings that makes us respond to them, are called stimuli.

Do other animals also respond to stimuli? Observe the behaviour of animals, when the food is served to them. Do you find them suddenly becoming active on seeing the food? When you move towards a bird, what does it do? Wild animals run away when bright light is flashed towards them. Similarly, cockroaches begin to move to their hiding places if the light in the kitchen is



switched on at night. Can you give some more examples of responses of animals to stimuli?

Do plants also respond to stimuli? Flowers of some plants bloom only at night. In some plants flowers close after sunset. In some plants like *Mimosa*, commonly known as ‘touch-me-not’, leaves close or fold when someone touches them. These are some examples of responses of plants towards changes in their surroundings.

Activity 4

Place a potted plant in a room a little away from a window through which sunlight enters some time during the day (Fig. 9.12). Continue watering the plant for a few days. Does the plant grow upright, like plants out in the open? Note the direction in which it bends, if it is not growing upright. Do you think, this may be in response to some stimulus?

All living things respond to changes around them.

Living organisms and excretion

All living things take food. Not all the food that is eaten is really used, only a part of it is utilised by the body. What happens to the rest? This has to be removed by the body as wastes. Our body also produces some wastes in other life processes. The process of getting rid of these wastes by the living organisms is known as excretion.

Do plants also excrete? Yes, they do. However, the mechanisms in plants are a little different. Some harmful or poisonous materials do get produced in plants as wastes. Some plants find it possible to store the waste products within their parts in a way that they do not harm the plant as a whole. Some plants remove waste products as secretions.

Excretion is another characteristics common to all living things.



Do all living things reproduce their own kind?

Have you ever seen nests of some birds like pigeons? Many birds lay their eggs in the nest. Some of the eggs may hatch and young birds come out of these (Fig. 9.13).

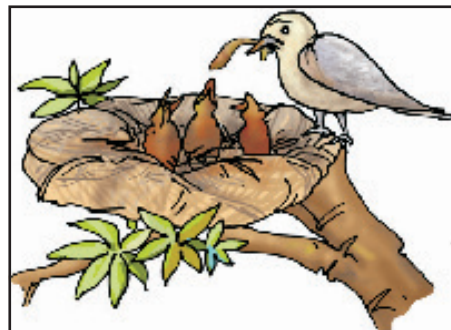
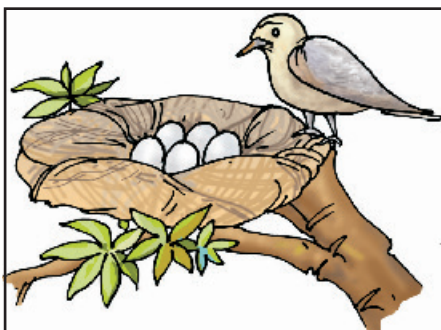

Fig 9.13 (a) Birds lay eggs which after hatching produce (b) young ones



Animals reproduce their own kind. The mode of reproduction may be different, in different animals. Some animals produce their young ones through eggs. Some animals give birth to the young ones (Fig. 9.14).

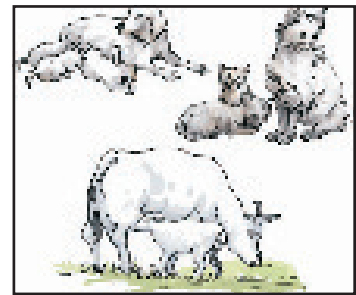

Fig 9.14 Some animals which give birth to their young ones



Fig 9.15 A seed from a plant germinates and grows into a new plant

Plants also reproduce. Like animals, plants also differ in their mode of reproduction. Many plants reproduce through seeds. Plants produce seeds, which can germinate and grow into new plants (Fig.9.15).

Some plants also reproduce through parts other than seeds. For example, a part of a potato with a bud, grows into a new plant (Fig 9.16).

Plants also reproduce through cuttings. Would you like to grow a plant in this way yourself?

Activity 5

Take a cutting from a rose or a mehndi plant. Fix it in the soil and water it regularly. What do you observe, after a few days?

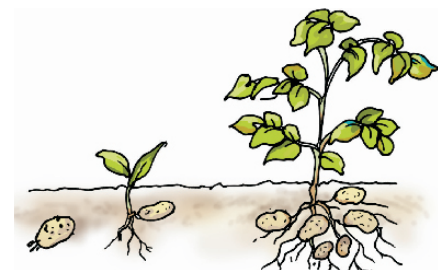

Fig 9.16 A new plant from a bud of potato

It may not be easy to grow plants from cuttings. Do not be disappointed if your cutting does not grow. Talk to a gardener, if possible, on the care to be given to cuttings to make them grow into plants.

Living things produce more of their own kind through reproduction. It takes place in many different ways, for different organisms.

Do all living things move?

In Chapter 8, we discussed the various ways in which animals move. They move from one place to another and also show other body movements.

What about plants? Do they also move? Plants are generally anchored in soil so they do not move from one place to another. However, various substances like water, minerals and the food synthesised by them move from one part of the plant to other. Have you noticed any other kind of movement in plants? Opening or closing of flowers? Do you recall how some plants show movement in response to certain stimuli?

We also have some non-living things moving, of course. A bus, car, a small piece of paper, clouds and so on. Is there something different in these movements from the movements of living beings?



There is such a variety of living organisms, but, all of them show some common characteristics, as we have discussed. Yet another common characteristic is that living beings die. Because organisms die, they can only survive over thousands of years if they reproduce their own kind. One single organism may die without ever reproducing, but, the type of organism can exist only if there is reproduction.

We see that, all living things seem to have some common characteristics. They all need food, respire, respond to stimuli, reproduce, show movement, grow and die.

Do we find some non-living things that also show some of these characteristics? Cars, bicycle, clocks and the water in the river move. The moon moves in the sky. A cloud grows in size right in front of our eyes. Can such things be called living? We ask ourselves, do these objects also show all the other characteristics of living things?

In general, something that is living may have all the characteristics that we have discussed, while non-living things may not show all these characteristics at the same time.

Is this always true? Do we always find that living things definitely show all the characteristics of the living that we have discussed? Do we always find that non-living things may show only some of these characteristics and never all of them?

To understand this a little better, let us look at a specific example. Consider any seed, say, moong. Is it living? It can stay in a shop for months and not show any growth or some of the other characteristics of life. However, we bring the same seed and plant it in soil, water it and it turns into a whole plant. Did the seed — need food, did it excrete, grow or reproduce when it was in the shop for many months?

We see that there can be cases when we cannot easily say that a thing has all the characteristics that we have discussed, for it to be called living.

“What then is life?”

Push your hand deep inside a sack of wheat. Do you find it is warm inside? There is some heat being produced inside the sack of wheat. The seeds respire and in that process give out some heat.

We see that respiration is a process that takes place in seeds even when some of the other life processes may not be very active.

It may not be very easy to answer our question — “what then is life”? However, looking at all the diversity of living beings around us, we can conclude that “life is beautiful”!





What You have Learnt

- The surroundings where plants and animals live, is called their habitat.
- Several kinds of plants and animals may share the same habitat.
- The presence of specific features and habits, which enable a plant or an animal to live in a particular habitat, is called adaptation.
- There are many types of habitats, however, these may be broadly grouped as terrestrial (on the land) and aquatic (in water).
- There is a wide variety of organisms present in different habitats.
- Plants, animals and microorganisms together constitute biotic components.
- Rocks, soil, air, water, light and temperature are some of the abiotic components of our surroundings.
- Living things have certain common characteristics — they need food, they respire and, excrete, respond to their environment, reproduce, grow and show movement. The surroundings where plants and animals live, is called their habitat.



Exercises

1. What is a habitat?
2. Why is adaptation necessary?
3. How is cactus adapted to survive in a desert?
4. Why is the body of water plants covered with mucilage?
5. Fill up the blanks
 - (a) The presence of specific features, which enable a plant or an animal to live in a particular habitat, is called———.
 - (b) The habitats of the plants and animals that live on land are called _____ habitat.
 - (c) The habitats of plants and animals that live in water are called _____ habitat.
 - (d) Soil, water and air are the ———— factors of a habitat.



- (e) Changes in our surroundings that make us respond to them are called ____
- (f) Water lily plant shows _____ adaptation.
6. Which of the things in the following list are nonliving?
Plough, Mushroom, Sewing machine, Radio, Boat, Water hyacinth, Earthworm
 7. Give an example of a non-living thing, which shows any two characteristics of living things.
 8. Which of the non-living things listed below, were once part of a living thing?
Butter, Leather, Soil, Wool, Electric bulb, Cooking oil, Salt, Apple, Rubber
 9. List the common characteristics of the living things.
 10. Explain why speed is important for survival in the grasslands for animals that live there. (Hint: There are few trees or places for animals to hide in grasslands habitats.)
 11. How do plants differ from animals? Give important differences?

SUGGESTED PROJECTS AND ACTIVITIES

1. Many magazines and newspapers talk about possibility of life outside the Earth. Read these articles and have a discussion in the class about what could be defined as life outside Earth.
2. Visit a local zoo and find out what special arrangements are made for the animals that have been brought there from different habitats.
3. Find out where are the habitats of the polar bear and the penguin. For each animal, explain two ways in which it is well adapted to its habitat.
4. Find out which animals live in the foot-hills of the Himalayas. Find out if the types and varieties of animals and plants changes as one goes higher into the mountain regions of the Himalayas.
5. Make a habitat album. Try to obtain pictures of animals and plants that you have listed in Activity 1 and paste these under different habitat sections in the album. Draw the leaf shapes and structures for trees found in these different regions and include these in the album. In addition, draw the patterns of branching found in trees of these different regions and include these also in the album.

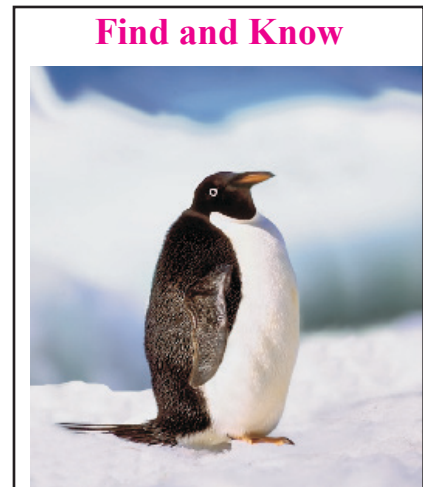

What is its name and habitat?

How these animals feed themselves in winter and summer?



Motion and Measurement of Distances

Keywords : Invention, Metric System, Periodic, Rational

There was a general discussion among the children in a class about the places they had visited during the summer vacations. Someone had gone to their native village by a train, then a bus, and finally a bullock cart. One student had travelled by an aeroplane. Another spent many days of his holidays going on fishing trips in his uncle's boat.

The teacher then asked them to read newspaper articles that mentioned about small wheeled vehicles that moved on the soil of Mars and conducted experiments. These vehicles were taken by spacecraft all the way to Mars! The students were curious to know how people travelled from one place to another in earlier times.

10.1 STORY OF TRANSPORT

Long ago people did not have any means of transport. They used to move only on foot and carry goods either on their back or using animals.

For transport along water routes, boats were used from ancient times. To begin with, boats were simple logs of wood in which a hollow cavity could be made. Later, people learnt to put together different pieces of wood and give shapes to the boats. These shapes imitated the shapes of the animals living in water. Recall our discussions of this streamlined shape of fish in Chapters 8 and 9.

Invention of the wheel made a great change in modes of transport. The design of the wheel was improved over thousands of years. Animals were used to pull vehicles that moved on wheels.

Until the beginning of the 19th century, people still depended on animal power to transport them from place to place. The invention of steam engine introduced a new source of power. Railroads were made for steam engine driven carriages and wagons. Later came automobiles. Motorised boats and ships were used as means of transport on water. The early years of 1900 saw the development of aeroplanes. These were later improved to carry passengers and goods. Electric trains, monorail, supersonic aeroplanes and spacecraft are some of the 20th century contributions.

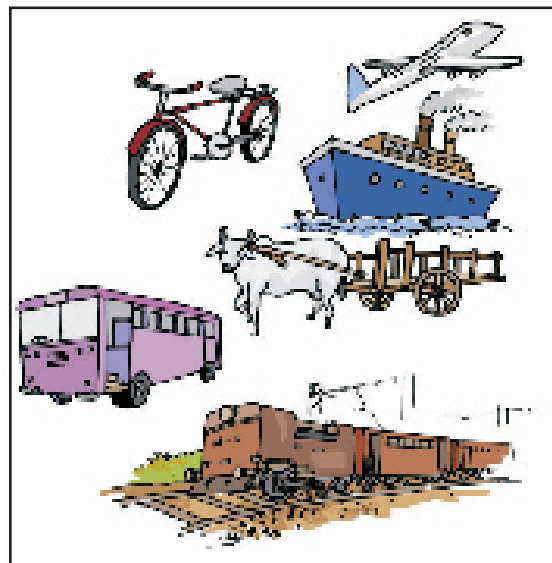

Fig 10.1 Means of transportation

Fig. 10.1 shows some of the different modes of transport. Place them in the correct order — from the earliest modes of transport to the most recent.



Are there any of the early modes of transport that are not in use today?

From this story, we can conclude that things are in motion; which is defined as, “When a body changes its position with respect to Surrounding or moves from one place to another”.

10.2 HOW FAR HAVE YOU TRAVELLED? HOW WIDE IS THIS DESK?

How did people know how far they have travelled?

How will you know whether you can walk all the way to your school or whether you will need to take a bus or a rickshaw to reach your school? When you need to purchase something, is it possible for you to walk to the market? How will you know the answers to these questions?

It is often important to know how far a place is, so that we can have an idea how we are going to reach that place — walk, take a bus or a train, a ship, an aeroplane or even a spacecraft!

Sometimes, there are objects whose length or width we need to know.

In classroom, there are large desks which are to be shared by two students. Frequently the students who share one desk end up fighting that the other is using a larger share of the desk.

On the teacher’s suggestion, they measure the length of the desk, make a mark exactly in the middle of it and draw a line to separate the two halves of the desk.

Also let us assume that we have no modern measuring devices. How could the desk be measured. All of us are familiar with “ Gilli Danda”. Keeping the Gilli and Danda over the desk, the half of the desk could be calculated. Also length could be measured with pencils you have in your bag. (Fig. 10.2).

Here is how, the length of the desk seems to measure using the gilli and danda (Fig. 10.3).

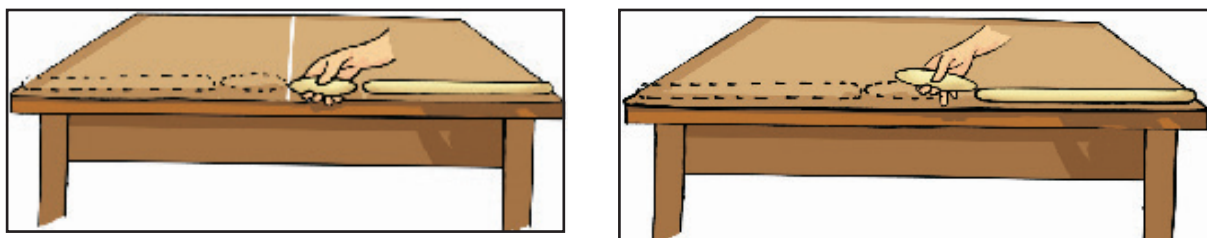

Fig 10.2 Measuring the length of a desk with gilli and danda

Fig 10.3 Measuring the length of the desk with a different set of gilli and danda

One thing we could do is to take a small length of string and mark two points on it. This will be a string length. We can measure the width of the desk in string lengths (Fig. 10.4). How can we use the string to measure distances less than the length of a string? We can fold the string and mark it into $\frac{1}{2}$, $\frac{1}{4}$ and $\frac{1}{8}$ ‘string lengths’. Now, perhaps we can measure the exact length of the desk using the string.

You would say that we should use the scale in our geometry box and solve our problem? Yes, Of course!



We have been reading about the way people used to measure distances before such standard scales were made and we have been trying to follow different methods of measuring distances.

There are so many occasions when we come across a need to measure lengths and distances. The tailor needs to measure the length of the cloth to know if it is enough to stitch a kurta. A carpenter needs to measure the height and width of a cupboard to know how much wood he would need to make its door. The farmer needs to know the length and breadth or the area of his land to know how much seed he can sow and how much water would be needed for his crops.



Fig 10.4 *Measuring the length of the desk with string lengths*

Suppose, you are asked how tall you are? You want to tell the length of a straight line from the top of your head to the heel of your feet.

How long is this broom?

How wide is this desk?

How far is it from Srinagar to Jammu?

How far away is the Moon from the Earth?

All these questions have one thing in common. They all concern distance between two places. The two places may be close enough, like the two ends of a table or they may be far apart, like Jammu and Kanyakumari. So, distance is defined as the actual path covered by the body”.

Let us do a few measurements to see what exactly we need to do, when we measure distances or lengths.

10.3 SOME MEASUREMENTS

Activity 1

Work in groups and each of you do this activity one by one. Using your foot as a unit of length, measure the length and breadth of the classroom. It is possible that while measuring these you may find some part remains to be measured as it is smaller than your foot. Use a string to measure the length of a part of your foot as you did before. Record your observations in Table 10.1.



Table 10.1 Measuring length and breadth of classroom

Name of the student	Length of the class room	Width of the class room

Activity 2

Work in a group and each of you use your handspan as a unit to measure the width of a table or a desk in the classroom (Fig. 10.5).

Here too, you may find that you need string lengths equal to your handspan and then fractions of this string length to make the measurement. Record all observations in Table 10.2.

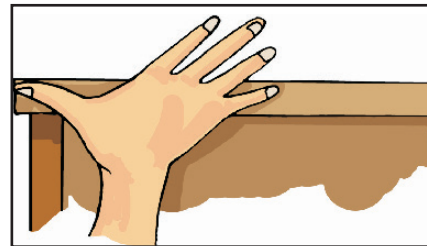

Fig 10.5 Measuring the width of table with a handspan

Table 10.2 Measuring width of a table

Who measured the width of the table	Number of handspans

We see that, measurement means the comparison of an unknown quantity with some known quantity. This known fixed quantity is called a unit. The result of a measurement is expressed in two parts. One part is a number. The other part is the unit of the measurement. For example, if in Activity 1, the length of the room is found to be 12 lengths of your foot, then 12 is the number and ‘foot length’ is the unit selected for the measurement.

Now, study all the measurements recorded in Table 10.1 and 10.2. Are all the measurements for the room using everybody’s foot, equal? Are everybody’s measurement, by handspan, of the width of the table equal? Perhaps the results could be different as the length of your handspan and that of your friends may not be the same. Similarly, the length of the foot may be slightly different for all the students. Therefore, when you tell your measurement using your handspan or length of foot as a unit to others, they will not be able to understand how big the actual length is, unless they know the length of your handspan or foot.

We see therefore, that some standard units of measurement are needed, that do not change from person to person.



10.4 STANDARD UNITS OF MEASUREMENTS

In ancient times, the length of a foot, the width of a finger, and the distance of a step were commonly used as different units of measurements.

The people of the Indus valley civilisation must have used very good measurements of length because we see evidence in excavations of perfectly geometrical constructions.

A cubit as the length from the elbow to the finger tips was used in ancient Egypt and was also accepted as a unit of length in other parts of the world.

People also used the “foot” as a unit of length in different parts of the world. The length of the foot used varied slightly from region to region.

People measured a yard of cloth by the distance between the end of the outstretched arm and their chin. The Romans measured with their pace or steps.

In ancient India, small length measurements used were an angul (finger) or a mutthi (fist). Even today, we can see flower sellers using their forearm as a unit of length for garlands in many towns of India. Many such body parts continue to be in use as unit of length, when convenient.

However, everyone’s body parts could be of slightly different sizes. This must have caused confusion in measurement. In 1790, the French created a standard unit of measurement called the metric system.

For the sake of uniformity, scientists all over the world have accepted a set of standard units of measurement. The system of units now used is known as the International System of Units (SI units). The SI unit of length is a metre. A metre scale is shown in Fig.10.6. Also shown is the 15 cm scale in your geometry box.

Each metre (m) is divided into 100 equal divisions, called centimetre (cm). Each centimetre has ten equal divisions, called millimetre (mm). Thus,

$$1 \text{ m} = 100 \text{ cm}$$

$$1 \text{ cm} = 10 \text{ mm}$$

For measuring large distances, metre is not a convenient unit. We define a larger unit of length. It is called kilometre (km).

$$1 \text{ km} = 1000 \text{ m}$$

Now, we can repeat all our measurement activities using a standard scale and measure in SI units. Before we do that, we do need to know the correct way of measuring lengths and distances.

10.5 CORRECT MEASUREMENT OF LENGTH

In our daily life we use various types of measuring devices. We use a metre scale for measuring length. A tailor uses a tape, whereas a cloth merchant uses a metre rod. For measuring



the length of an object, you must choose a suitable device. You cannot measure the girth of a tree or the size of your chest using a metre scale, for instance. Measuring tape is more suitable for this. For small measurements, such as the length of your pencil, you can use a 15 cm scale from your geometry box.



Fig 10.6 A metre scale and a 15 cm scale

In taking measurement of a length, we need to take care of the following:

1. Place the scale in contact with the object along its length as shown in Fig.10.7.
2. In some scales, the ends may be broken. You may not be able to see the zero mark clearly (Fig.10.8 (a)). In such cases, you should avoid taking measurements from the zero mark of the scale. You can use any other full mark of the scale, say, 1.0 cm [Fig.10.8 (b)]. Then you must subtract the reading of this mark from the reading at the other end. For example, in Fig.10.8 (b) the reading at one end is 1.0 cm and at the other end it is 14.3 cm. Therefore, the length of the object is $(14.3 - 1.0) \text{ cm} = 13.3 \text{ cm}$.

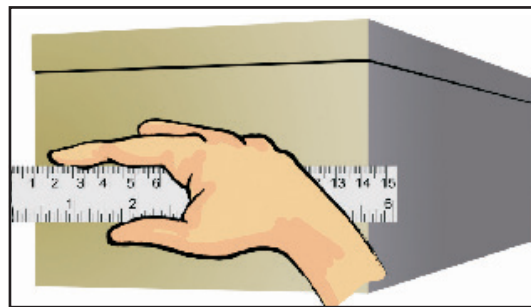

Fig 10.7 Method of placing the scale along the length to be measured (a) correct (b) incorrect

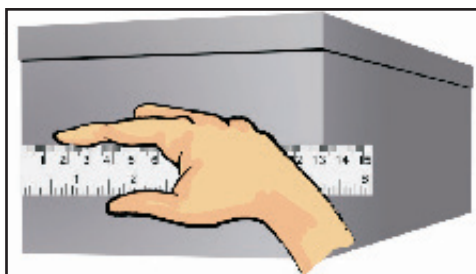

Fig 10.8 (a) incorrect and (b) correct method of placing the scale with broken edge



- Correct position of the eye is also important for taking measurement. Your eye must be exactly in front of the point where the measurement is to be taken as shown in Fig.10.9. Position 'B' is the correct position of the eye. Note that from position 'B', the reading is 7.5 cm. From positions 'A' and 'C', the readings may be different.

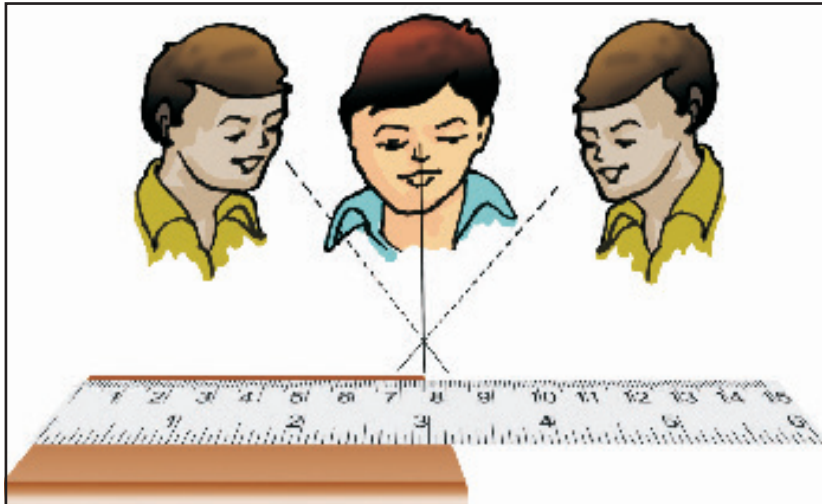

Fig 10.9 B is the proper position of the eye for taking reading of the scale

Activity 3

Measure the height of your classmate using hand span and then by using a metre scale. For this, ask your classmate to stand with his back against a wall. Make a mark on the wall exactly above his head. Now, measure the distance from the floor to this mark on the wall with your handspan and then with a metre scale. Let all other students measure this length in a similar way. Record all observations in Table 10.3.

Table 10.3 Measurement of height

Who measured the height	Height in handspan	Height in cm

Study carefully results obtained by different students. The results in column 2 may be different from each other as the length of the handspan may be different for different students. Look at the results in column 3 where the measurements are done using a standard scale. The results may be close to each other now, but, are they exactly equal? If not, why do you think



there is a difference? After all, everybody is using the same scale and not different hand spans. This could be due to small errors in taking observations. In higher classes we will learn about the importance of knowing and handling such errors in measurement.

10.6 MEASURING THE LENGTH OF A CURVED LINE

We cannot measure the length of a curved line directly by using a metre scale. We can use a thread to measure the length of a curved line.

Activity 4

Use a thread to measure the length of the curved line AB (Fig.10.10). Put a knot on the thread near one of its ends. Place this knot on the point A. Now, place a small portion of the thread along the line, keeping it taut using your fingers and thumb. Hold the thread at this end point with one hand. Using the other hand, stretch a little more portion of the thread along the curved line. Go on repeating this process till the other end B of the curved line is reached. Make a mark on the thread where it touches the end B. Now stretch the thread along a metre scale. Measure the length between the knot in the beginning and the final mark on the thread. This gives the length of the curved line AB.



Fig 10.10 Measuring the length of a curved line with a thread

We see that we need a lot of care to ensure that we are measuring distances and lengths correctly. And, we need some standard units and devices with which we measure these distances and can convey our results to others.

10.7 MOVING THINGS AROUND US

Activity 5

Think of some objects you have seen recently. List them in Table 10.4. A school bag, a mosquito, a table, people sitting on desks, people moving about? May be a butterfly, dog, cow, your hand, a small baby, a fish in water, a house, a factory, a stone, a horse, a ball, a bat, a moving train, a sewing machine, a wall clock, hands of a clock? Make your list as large as you can.

Table 10.4 Objects in rest and motion

Objects at rest	Objects in motion
House	A flying bird
Table	Second's hand of the clock
Clock	



Which of these are moving? Which are at rest?

How did you decide whether an object is in motion or at rest?

You might have noticed that the bird is not at the same place after some time, while the table is at the same place. On this basis you may have decided whether an object is at rest or in motion.

Let us look at the motion of an ant closely.

Activity 6

Spread a large sheet of white paper on the ground and keep a little sugar on it. Ants are likely to be attracted to the sugar and you will find many ants crawling on the sheet of paper soon. For any one ant, try and make a small mark with a pencil near its position when it has just crawled on to the sheet of paper (Fig. 10.11). Keep marking its position after a few seconds as it moves along on the sheet of paper. After some time, shake the paper free of the sugar and the ants. Connect the different points you have marked, with arrows, to show the direction in which the ant was moving. Each point you have marked shows where the ant moved to, in intervals of a few seconds.

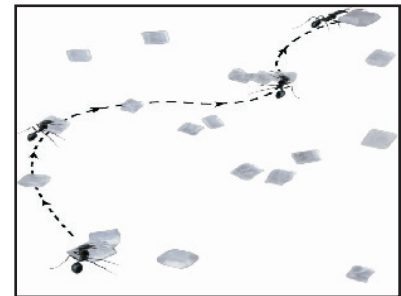

Fig 10.11 Motion of an ant

Motion seems to be some kind of a change in the position of an object with time, isn't it?

In Activity 5, where did you place objects like a clock, a sewing machine or an electric fan in your grouping of objects? Are these objects moving from one place to other? No? Do you notice movement in any of their parts? The blades of the fan or the hands of a clock— how are they moving? Is their movement similar to that of a train? Let us now look at some types of motion to help us understand these differences.

10.8 TYPES OF MOTION

You may have observed the motion of a vehicle on a straight road, march-past of soldiers in a parade or the falling of a stone (Fig. 10.12). What kind of motion is this? Sprinters in a 100-metre

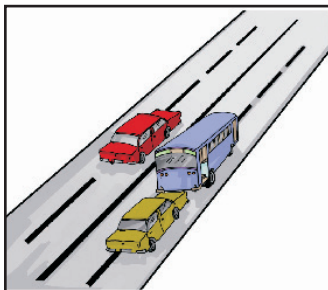

(a)

race also move along a straight track. Can you think of more such examples from your surroundings?

In all these examples we see that the objects move along a straight line. This type of motion is called rectilinear motion.



(b)

Fig 10.12 Some examples of rectilinear motion



Activity 7

Take a stone, tie a thread to it and whirl it with your hand. Observe the motion of the stone. We see that the stone moves along a circular path.

In this motion, the distance of the stone from your hand remains the same. This type of motion is called circular motion (Fig. 10.13).

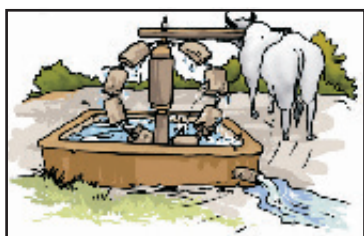

(a)

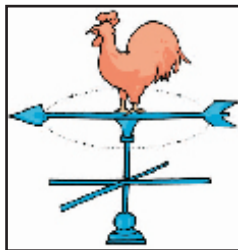

(b)

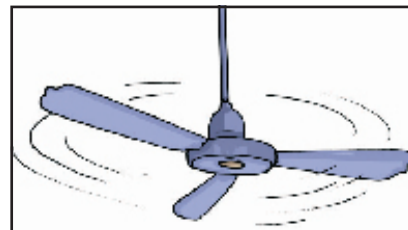

(c)

Fig 10.13 Some objects in circular motion

The motion of a point marked on the blade of an electric fan or the hands of a clock are examples of circular motion.

The electric fan or the clock by themselves are not moving from one place to another. But, the blades of the fan rotate and so do the hands of a clock. If we mark a point anywhere on the blades of a fan or on the hands of a clock, the distance of this point from the centre of the fan or the clock, will remain the same as they rotate.

In some cases, an object repeats its motion after some time. This type of motion is called periodic motion. Take the stone tied with a string that you used in Activity 6. Now, hold the string in your hand and let the stone hang from it. Pull the stone to one side with the other hand and let it go. This is a pendulum. Something to have a lot of fun with and something that will help us understand about periodic motion. Motion of a pendulum, a branch of a tree moving to and fro, motion of a child on a swing, strings of a guitar or the surface of drums (tabla) being played, are all examples of periodic motion where an object or a part of it repeats its motion after a fixed interval of time (Fig. 10.14).

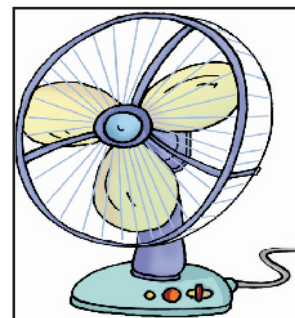

(a)

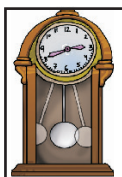

(b)

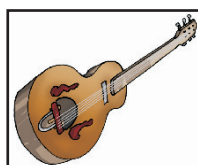

(c)

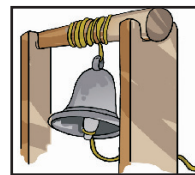

(d)



(e)

Fig 10.14 Examples of periodic motion



Did you observe a sewing machine as a part of Activity 5? You must have observed that it remains at the same location while its wheel moves with a circular motion. It also has a needle that moves up and down continuously, as long as the wheel rotates, isn't it? This needle is undergoing a periodic motion.

Have you observed closely, the motion of a ball on the ground? Here, the ball is rolling on the ground – rotating as well as moving forward on the ground. Thus, the ball undergoes a rectilinear motion as well as rotational motion. Can you think of other examples where objects undergo combinations of different types of motion?

We did many measurement activities and discussed some kinds of motion. We saw that motion is a change in the position of an object with time.

The change in this position can be determined through distance measurements. This allows us to know how fast or slow a motion is. The movement of a snail on the ground, a butterfly flitting from flower to flower, a river flowing along on clear rounded pebbles, an aeroplane flying high up in the air — making jet trails, moon going around the Earth, blood flowing inside our bodies, there is motion everywhere around us!



What You have Learnt

- Different modes of transport are used to go from one place to another.
- In ancient times, people used length of a foot, the width of a finger, the distance of a step as units of measurement. This caused confusion and a need to develop a uniform system of measurement arose.
- Now, we use International System of Unit (SI unit). This is accepted all over the world.
- Metre is the unit of length in SI unit.
- Motion in a straight line is called rectilinear motion.
- In circular motion an object moves such that its distance from a fixed point remains the same.
- Motion that repeats itself after some period of time, is called periodic motion.





Exercises

1. Give two examples each, of modes of transport used on land, water and air.
2. Fill in the blanks:
 - (i) One metre is _____ cm.
 - (ii) Five kilometre is _____ m.
 - (iii) Motion of a child on a swing is _____.
 - (iv) Motion of the needle of a sewing machine is _____.
 - (v) Motion of wheel of a bicycle is _____.
 - (vi) The $\frac{1}{1000}$ part of meter is called _____
 - (vii) 1000 times the length of meter is called _____ -
3. Why can a pace or a footstep not be used as a standard unit of length?
4. Arrange the following lengths in their increasing magnitude:
1 metre, 1 centimetre, 1 kilometre, 1 millimetre.
5. The height of a person is 1.65 m. Express it into cm and mm.
6. The distance between Radha's home and her school is 3250 m. Express this distance into km.
7. While measuring the length of a knitting needle, the reading of the scale at one end is 3.0 cm and at the other end is 33.1 cm. What is the length of the needle?
8. Write the similarities and differences between the motion of a bicycle and a ceiling fan that has been switched on.
9. Why could you not use an elastic measuring tape to measure distance? What would be some of the problems you would meet in telling someone about a distance you measured with an elastic tape?
10. Give two examples of periodic motion.
11. You are sitting in a moving bus and looking out? Are you in a state of motion or rest? Explain
12. Giving at least two examples, define the terms.
 - a. Rectilinear motion



- b. Rotatory motion
- c. Oscillatory motion
- d. Periodic motion

SUGGESTED PROJECTS AND ACTIVITIES

1. Draw a map of your classroom. Roll a ball on the floor. In your map mark the points where the ball started and where it stopped. Show also the path it moved along. Did the ball move along a straight line?
2. Using string and a scale, let each student measure the length of his/her foot. Prepare a bar graph of the foot length measurements that have been obtained for the whole class.

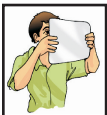

Light, Shadows and Reflections

Keywords : Pinhole, Image, Eclipse, Reflection

We see so many objects around us, colourful and different.

On the way to school we see things like buses, cars, cycles, trees, animals and sometimes flowers. How do you think, we see all these objects?

Think of the same places at night time if it were completely dark. What will you see? Suppose you go inside a completely dark room. Are you able to see any objects in the room?

But, when you light a candle or a torch you can see the objects present in the room, isn't it? Without light, things cannot be seen. Light helps us to see objects.

The torch bulb is an object that gives out light of its own. The Sun is another familiar object that gives its own light. During the day, its light allows us to see objects. Objects like the sun that give out or emit light of their own are called luminous objects.



THINK:

Why is moon considered a non luminous object?

What about objects like a chair, a painting or a shoe? We see these when light from a luminous object (like the Sun, a torch or an electric light) falls on these and then travels towards our eye.

11.1 TRANSPARENT, OPAQUE AND TRANSLUCENT OBJECTS

Recall our grouping objects as opaque, transparent or translucent, in Chapter 4. If we cannot see through an object at all, it is an opaque object. If you are able to see clearly through an object, it is allowing light to pass through it and is transparent. There are some objects through which we can see, but not very clearly. Such objects are known as translucent.

Activity 1

Look around you and collect as many objects as you can — an eraser, plastic scale, pen, pencil, notebook, single sheet of paper, tracing paper or a piece of cloth. Try to look at something far away, through each of these objects (Fig. 11.1). Is light from a far away object able to travel to your eye, through any of the objects?

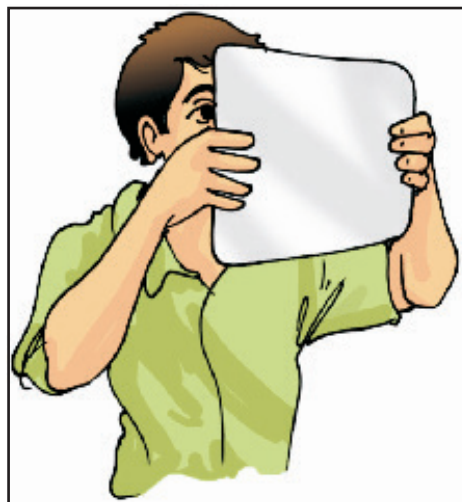

Fig 11.1 Observing objects that do or do not allow light to pass through them



Record your observations in a table as shown in Table 11.1.

Table 11.1

Objects /material	View through the object possible fully/partially/ not at all	Object is opaque/ transparent/translucent
Pencil		
Rubber ball		
Sheet of writing paper	Not very sure?	

We see that a given object or material could be transparent, translucent or opaque depending on whether it allows light to pass through it completely, partially or not at all.

11.2 WHAT EXACTLY ARE SHADOWS?

Activity 2

Now, one by one hold each of the opaque objects in the sunlight, slightly above the ground. What do you see on the ground? You know that the dark patch formed by each on the ground is due to its shadow. Sometimes you can identify the object by looking at its shadow (Fig. 11.2).

Spread a sheet of paper on the ground. Hold a familiar opaque object at some height, so that its shadow is formed on the sheet of paper on the ground. Ask one of your friends to draw the outline of the shadow while you are holding the object. Draw outlines of the shadows of other objects in a similar way.

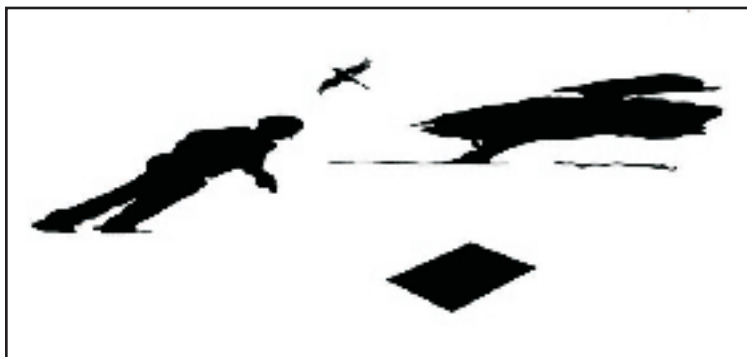

Now, ask some other friends to identify the objects from these outlines of shadows. How many objects are they able to identify correctly?

Fig 11.2 Sometimes shadow on an object gives an idea about its shape

Do you observe your shadow in a dark room or at night when there is no light? Do you observe a shadow when there is just a source of light and nothing else, in a room? It seems we need a source of light and an opaque object, to see a shadow. Is there anything else required?

Activity 3

This is an activity that you will have to do in the dark. In the evening, go out in an open ground with a few friends. Take a torch and a large sheet of cardboard with you. Hold the torch



close to the ground and shine it upwards so that its light falls on your friend's face. You now have a source of light that is falling on an opaque object. If there were no trees, building or any other object behind your friend, would you see the shadow of your friend's head? This does not mean that there is no shadow. After all, the light from the torch is not able to pass through his body to the other side.

Now, ask another friend to hold the cardboard sheet behind your friend. Is the shadow now seen on the cardboard sheet (Fig. 11.3)?



Fig 11.3 A shadow is obtained only on screen

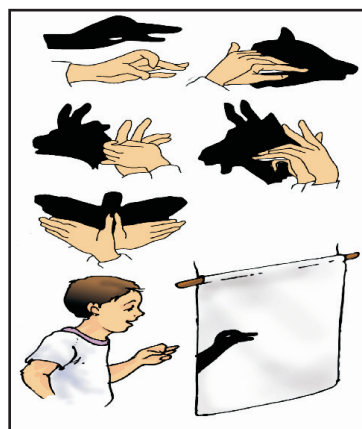

Fig 11.4 Shadows of animals hidden in your hand

Thus, the shadow can be seen only on a screen. The ground, walls of a room, a building, or other such surfaces act as a screen for the shadows you observe in everyday life.

Shadows give us some information about shapes of objects. Sometimes, shadows can also mislead us about the shape of the object. In Fig. 11.4 are a few shadows that we can create with our hands and make-believe that they are shadows of different animals. Have fun!

Activity 4

Place a chair in the school ground on a sunny day. What do you observe from the shadow of the chair?

Does the shadow give an accurate picture of the shape of the chair? If the chair is turned around a little, how does the shape of the shadow change?

Take a thin notebook and look at its shadow. Then, take a rectangular box and look at its shadow. Do the two shadows seem to have a similar shape?

Take flowers or other objects of different colours and look at their shadows. A red rose and a yellow rose, for instance. Do the shadows look different in colour, when the colours of the objects are different?

Take a long box and look at its shadow on the ground. When you move the box around, you



may see that the size of the shadow changes. When is the shadow of the box the shortest, when the long side of the box is pointed towards the Sun or when the short side is pointing towards the Sun?

Let us use this long box, to prepare a simple camera.

Do You Know
The light of the sun reaches to us in 8 minutes at a speed of 300000 km/s.

11.3 A PINHOLE CAMERA

Surely we need a lot of complicated stuff to make a camera? Not really. If we just wish to make a simple pin hole camera.

Activity 5

Take two boxes so that one can slide into another with no gap in between them. Cut open one side of each box. On the opposite face of the larger box, make a small hole in the middle [Fig. 11.5 (a)]. In the smaller box, cut out from the middle a square with a side of about 5 to 6 cm. Cover this open square in the box with tracing paper (translucent screen) [Fig. 11.5 (b)]. Slide the smaller box inside the larger one with the hole, in such a way that the side with the tracing paper is inside [Fig. 11.5 (c)]. Your pin hole camera is ready for use.

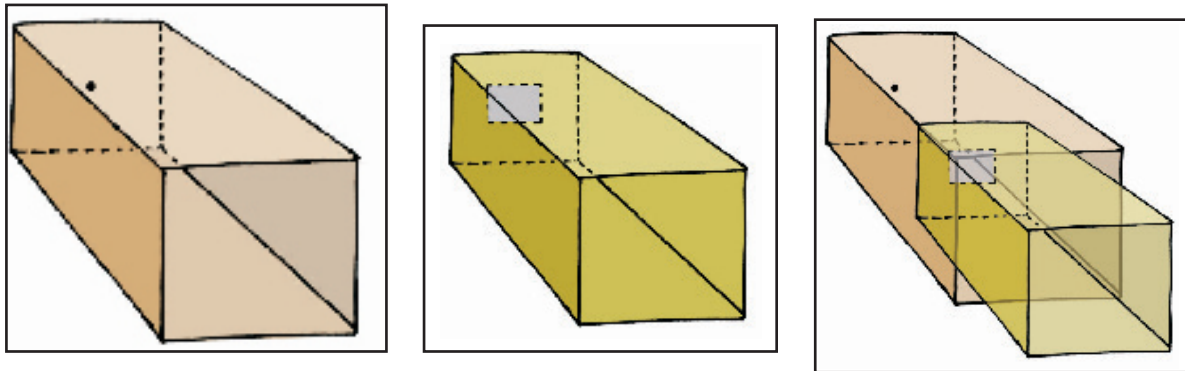

Fig 11.5 A sliding pin hole camera

Holding the pin hole camera look through the open face of the smaller box. You should use a piece of black cloth to cover your head and the pinhole camera. Now, try to look at some distant objects like a tree or a building through the pinhole camera. Make sure that the objects you wish to look at through your pinhole camera are in bright sun shine. Move the smaller box forward or backward till you get a picture on the tracing paper pasted at the other end.

Are these pin hole images different from their shadows?

Look through your pin hole camera at the vehicles and people moving on the road in bright sun light.



Fig 11.6 A natural pinhole camera. Pinhole images of the sun under tree



Do the pictures seen in the camera show the colours of the objects on the other side? Are the images erect or upside down? Surprise, surprise!

Let us now image the Sun, with our pin hole camera. We need a slightly different set up for this. We just need a large sheet of cardboard with a small pin hole in the middle. Hold the sheet up in the Sun and let its shadow fall on a clear area. Do you see a small circular image of the Sun in the middle of the shadow of the cardboard sheet?

Look at these pin hole images of the Sun when an eclipse is visible from your location. Adjust your pin hole and screen to get a clear image before the eclipse is to occur. Look at the image as the eclipse begins. You will notice a part of the Sun's image gradually becoming darker as the eclipse starts. Never ever look directly at the Sun. That could be extremely harmful for the eyes.

There is an interesting pin hole camera in Nature. Sometimes, when we pass under a tree covered with large number of leaves, we notice small patches of sun light under it (Fig. 11.6). These circular images are, in fact, pin hole images of the Sun. The gaps between the leaves, act as the pin holes. These gaps are all kinds of irregular shapes, but, we can see circular images of the Sun. Try to locate images of the Sun when an eclipse occurs next. That could be so much fun!

We saw upside down images of people on the road, with our pinhole camera. What about the images of the Sun? Did we notice them to be upside down or anything like that?

Surely, all these results that we are seeing, formation of shadows and pinhole images are possible only if light moves in a straight path?

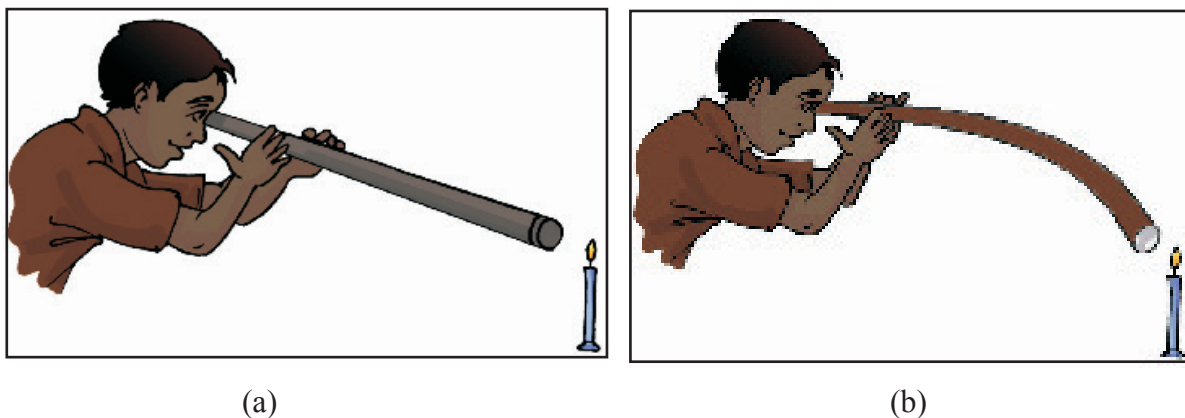

Fig 11.7 Looking through a pipe pointed (towards and (b) a little away from a candle

Activity 6

Let us use a piece of a pipe or a long rubber tube. Light a candle and fix it on a table at one end of the room. Now standing at the other end of the room look at the candle through the pipe [Fig. 11.7 (a)]. Is the candle visible? Bend the pipe a little while you are looking at the candle [Fig. 11.7 (b)].



Is the candle visible now? Turn the pipe a little to your right or left. Can you see the candle now?

What do you conclude from this?

This suggests that light travels along a straight line, isn't it? That is why, when opaque objects obstruct it, a shadow forms.

11.4 MIRRORS AND REFLECTIONS

We all use mirrors at home. You look into the mirror and see your own face inside the mirror. What you see is a reflection of your face in the mirror. We also see reflections of other objects that are in front of the mirror. Sometimes, we see reflections of trees, buildings and other objects in the water of a pond or a lake.

Activity 7

This activity should be done at night or in a dark room. Ask one of your friends to hold a mirror in his/her hand at one corner of the room. Stand at another corner with a torch in your hand. Cover the glass of torch with your fingers and switch it on. Adjust your fingers with a small gap between them so that you can get a beam of light. Direct the beam of the torch light onto the mirror that your friend is holding. Do you see a patch of light on the other side (Fig. 11.8)? Now, adjust the direction of the torch so that the patch of light falls on another friend standing in the room.

This activity suggests that a mirror changes the direction of light that falls on it.

Here is an activity that shows light travelling along straight lines and getting reflected from a mirror.

Activity 8

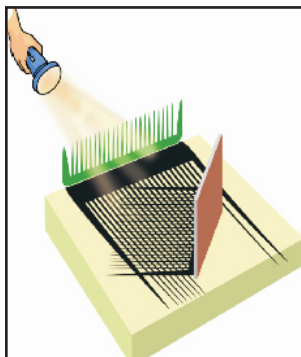

Fig 11.9 Light traveling in a straight line and getting reflected from a mirror

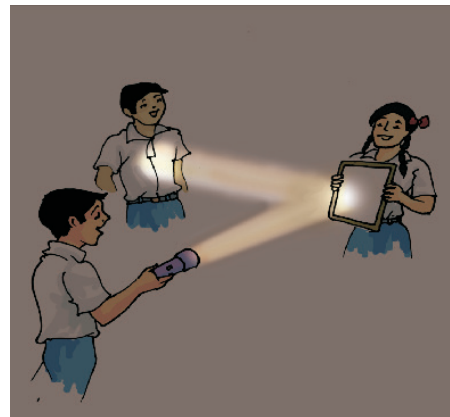

Fig 11.8 A mirror reflects a beam of light

Fix a comb on one side of a large thermocol sheet and fix a mirror on the other side as shown in Fig. 11.9. Spread a dark coloured sheet of paper between the mirror and the comb. Keep this in sunlight or send a beam of light from a torch through the comb.

What do you observe? Do you get a pattern similar to that shown in Fig. 11.9?

This activity gives us an idea of the manner in which light travels and gets reflected from a mirror.



What You have Learnt

- Opaque objects do not allow light to pass through them.
- Transparent objects allow light to pass through them and we can see through these objects clearly.
- Translucent objects allow light to pass through them partially.
- Shadows are formed when an opaque object comes in the path of light.
- Pinhole camera can be made with simple materials and can be used to image the Sun and brightly lit objects.
- Mirror reflection gives us clear images.
- Images are very different from shadows.
- Light travels in straight line.



Exercises

1. Rearrange the boxes given below to make a sentence that helps us understand opaque objects.

OWS	AKE	OPAQ	UEO	BJEC	TSM	SHAD
-----	-----	------	-----	------	-----	------

--	--	--	--	--	--	--

2. Classify the objects or materials given below as opaque, transparent or translucent and luminous or non-luminous:

Air, water, a piece of rock, a sheet of aluminium, a mirror, a wooden board, a sheet of polythene, a CD, smoke, a sheet of plane glass, fog, a piece of red hot iron, an umbrella, a lighted fluorescent tube, a wall, a sheet of carbon paper, the flame of a gas burner, a sheet of cardboard, a lighted torch, a sheet of cellophane, a wire mesh, kerosene stove, sun, firefly, moon.

3. Can you think of creating a shape that would give a circular shadow if held in one way and a rectangular shadow if held in another way?
4. In a completely dark room, if you hold up a mirror in front of you, will you see a reflection of yourself in the mirror?



SUGGESTED ACTIVITIES

1. Make a row of your friends — A, B, C and D, standing in a line. Let one friend stand in front facing them and holding out a mirror towards them (Fig. 11.10).

Now, each person can tell who they are able to see in the Mirror. A,B, C, or D.

If, A is able to see B in the mirror then, can B also see A in the mirror? Similarly, for any two pairs amongst A,B,C, or D?

If A is not able to see B in the mirror, then, is B able to see A in the mirror?

Similarly, for any two pairs amongst A,B,C, or D?

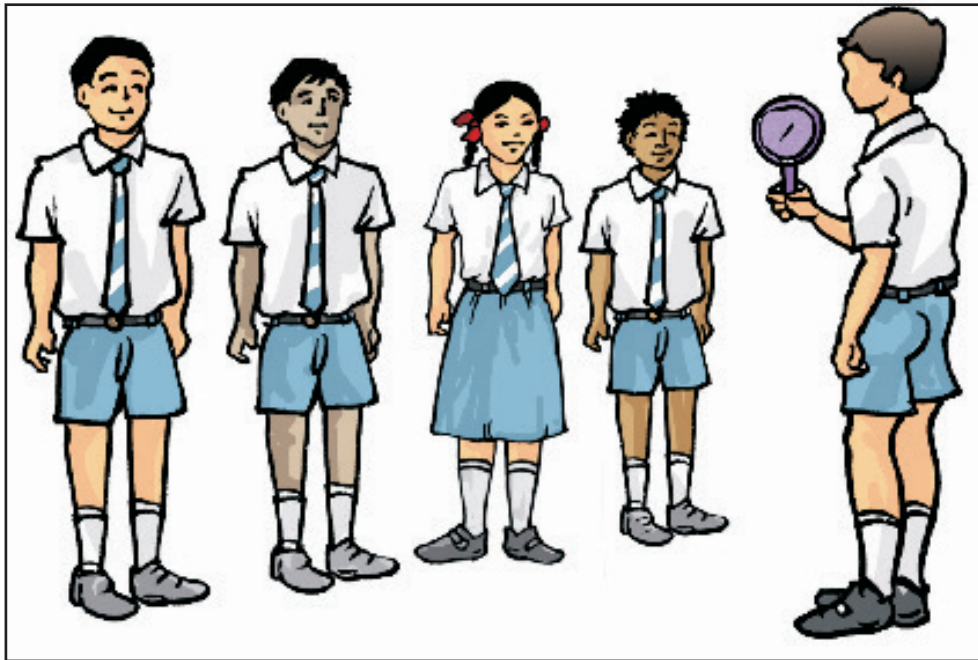

Fig 11.10

This activity tells us something about the way light travels and gets reflected from mirrors. You will learn more about this in higher classes.

2. Daayan-Baayan—Take a comb in your right hand and bring it up to your hair and look at yourself in the mirror. There is your familiar face, grinning at you.

Wait, try and find out which is the hand holding the comb, in your mirror reflection. Is it the right hand or the left? You were holding it in your right hand, isn't it?

While a pin hole camera seems to be giving us upside down images, a mirror seems to be turning right hand into left hand and the left into right hand. We will learn more about this in the higher classes.

3. Magic Device—In the chapter on symmetry in your Mathematics textbook, you might have made an interesting device Kaleidoscope, that uses reflections. Now, let us make another



device, a periscope, that uses reflections to see around corners! Ask one of your friends to stand in the corridor just outside the entrance to the classroom with a mirror in hand. Ask another friend also holding a mirror, to stand in the middle of classroom in front of the entrance. Now ask your friends to adjust their mirrors in such a way that the image of object on the other side of the corridor becomes visible to you while you are standing inside the class (Fig. 11.11).

You can make a simple periscope by placing two mirrors in a 'Z' shaped box as shown in Fig. 11.12.

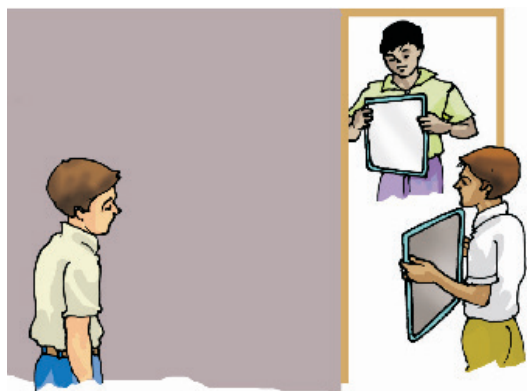

Fig 11.11 Seeing around corners

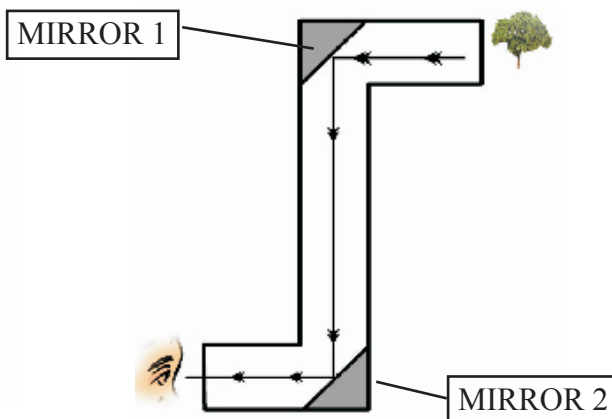

Fig 11.12 A periscope

THINGS TO THINK ABOUT

1. Opaque objects cast shadows, isn't it? Now, if we hold a transparent object in the Sun, do we see anything on the ground that gives us a hint that we are holding something in our hand?
2. We saw that changing colour of opaque objects does not change the colour of their shadows. What happens if we place an opaque object in coloured light? You can cover the face of a torch with a coloured transparent paper to do this. (Did you ever noticed the colours of evening shadows just as the Sun is setting?)

THINGS TO READ

Rudyard Kipling's "Just So Stories" and in particular, the story of "How the Leopard got its spots" where he mentions stripy, speckly, patchy-blatchy shadows. Here are a few lines from this story, that has a lot of shadows.

...after ever so many days, they saw a great, high, tall forest full of tree trunks all 'scclusively speckled and spottled and spottled, dotted and splashed and slashed and hatched and cross-hatched with shadows. (Say that quickly aloud, and you will see how very shadowy the forest must have been.)

'What is this,' said the Leopard, 'that is so 'scclusively dark, and yet so full of little pieces of light?'



Electricity and Circuits

Keywords : Terminal, Conduction, Insulation, Appliances

We use electricity for many purposes to make our tasks easier. For example, we use electricity to operate pumps that lift water from wells or from ground level to the roof top tank. What are other purposes for which you use electricity? List some of them in your notebook.

Does your list include the use of electricity for lighting? Electricity makes it possible to light our homes, roads, offices, markets and factories even after sunset. This helps us to continue working at night. A power station provides us with electricity. However, the supply of electricity may fail or it may not be available at some places. In such situations, a torch is sometimes used for providing light. A torch has a bulb that lights up when it is switched on. Where does the torch get electricity from?

12.1. ELECTRIC CELL

Electricity to the bulb in a torch is provided by the electric cell. Electric cells are also used in alarm clocks, wristwatches, transistor radios, cameras and many other devices. Have you ever carefully looked at an electric cell? You might have noticed that it has a small metal cap on one side and a metal disc on the other side (Fig. 12.1). Did you notice a positive (+) sign and a negative (-) sign marked on the electric cell? The metal cap is the positive terminal of the electric cell. The metal disc is the negative terminal. All electric cells have two terminals; a positive terminal and a negative terminal.

An electric cell produces electricity from the chemicals stored inside it. When the chemicals in the electric cell are used up, the electric cell stops producing electricity. The electric cell then has to be replaced with a new one.



Fig 12.1 An Electric Cell



You might have seen the danger sign shown here displayed on poles, electric substations and many other places. It is to warn people that electricity can be dangerous if not handled properly. Carelessness in handling electricity and electric devices can cause severe injuries and sometimes even death. Hence, you should never attempt to experiment with the electric wires and sockets. Also remember that the electricity generated by portable generators is equally dangerous. Use only electric cells for all activities related to electricity.



A torch bulb has an outer case of glass that is fixed on a metallic base [Fig. 12. 2 (a)]. What is inside the glass case of the bulb?

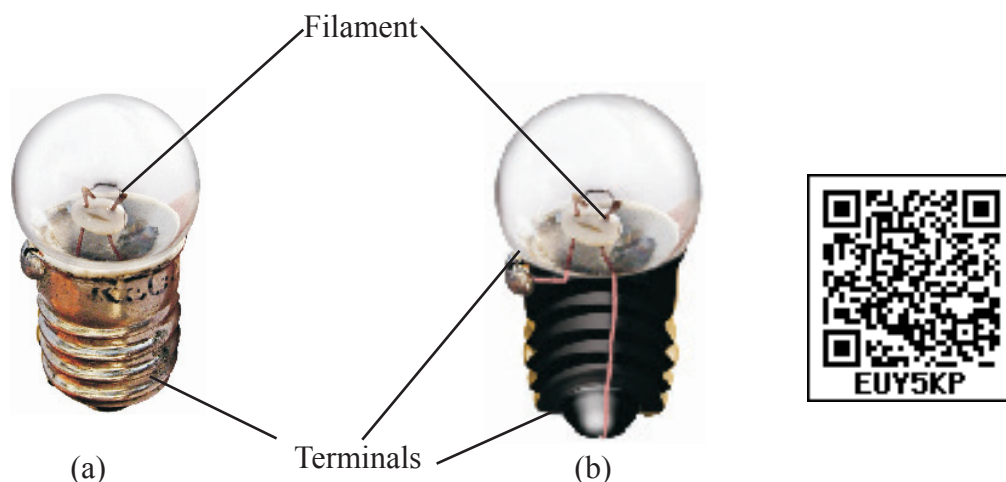

Fig 12.2 (a) Torch bulb and (b) its inside view

Activity 1

Take a torch and look inside its bulb. You can also take out the bulb with the help of your teacher. What do you notice? Do you find a thin wire fixed in the middle of the glass bulb [Fig. 12.2 (b)]? Now switch the torch on and observe which part of the bulb is glowing.

The thin wire that gives off light is called the filament of the bulb. The filament is fixed to two thicker wires, which also provide support to it, as shown in Fig. 12.2 (b). One of these thick wires is connected to the metal case at the base of the bulb [Fig. 12.2 (b)]. The other thick wire is connected to the metal tip at the centre of the base. The base of the bulb and the metal tip of the base are the two terminals of the bulb. These two terminals are fixed in such a way that they do not touch each other. The electric bulbs used at home also have a similar design.

Thus, both the electric cell and the bulb have two terminals each. Why do they have these two terminals?

12.2. A BULB CONNECTED TO AN ELECTRIC CELL

Let us try to make an electric bulb light up using an electric cell. How do we do that?

Activity 2

Take four lengths of electric wire with differently coloured plastic coverings. Remove a little of the plastic covering from each length of wire at the ends. This would expose the metal wires at the ends of each length. Fix the exposed parts of two wires to the cell and the other two of the bulb as shown in Fig. 12.3 and Fig. 12.4.

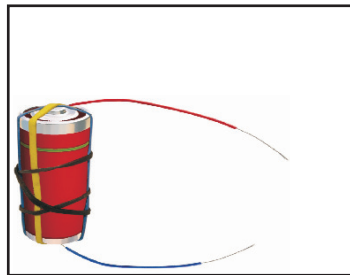

Fig 12.3 *Electric cell with two wires attached to it*

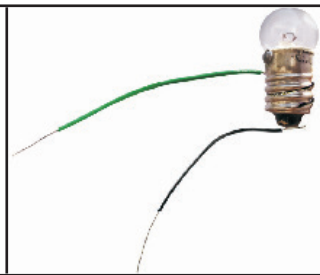

Fig 12.4 *Bulb connected to two wires*

You can stick the wires to the bulb with the tape used by electricians. Use rubber bands or tape to fix the wires to the cell.

Now, connect the wires fixed to the bulb with those attached to the cell in six different ways as has been shown in Fig. 12.5 (a) to (f). For each arrangement, find out whether the bulb glows or not. Write ‘Yes’ or ‘No’ for each arrangement in your notebook.

Now, carefully look at the arrangements in which the bulb glows. Compare these with those in which the bulb does not glow. Can you find the reason for the difference?

Keep the tip of your pencil on the wire near one terminal of the electric cell for the arrangement in Fig. 12.5 (a). Move the pencil along the wire all the way to the bulb. Now, from the other terminal of the bulb, move along the other wire connected to the cell. Repeat this exercise for all the other arrangements in Fig. 12.5. Did the bulb glow for the arrangements in which you could not move the pencil from one terminal to the other?

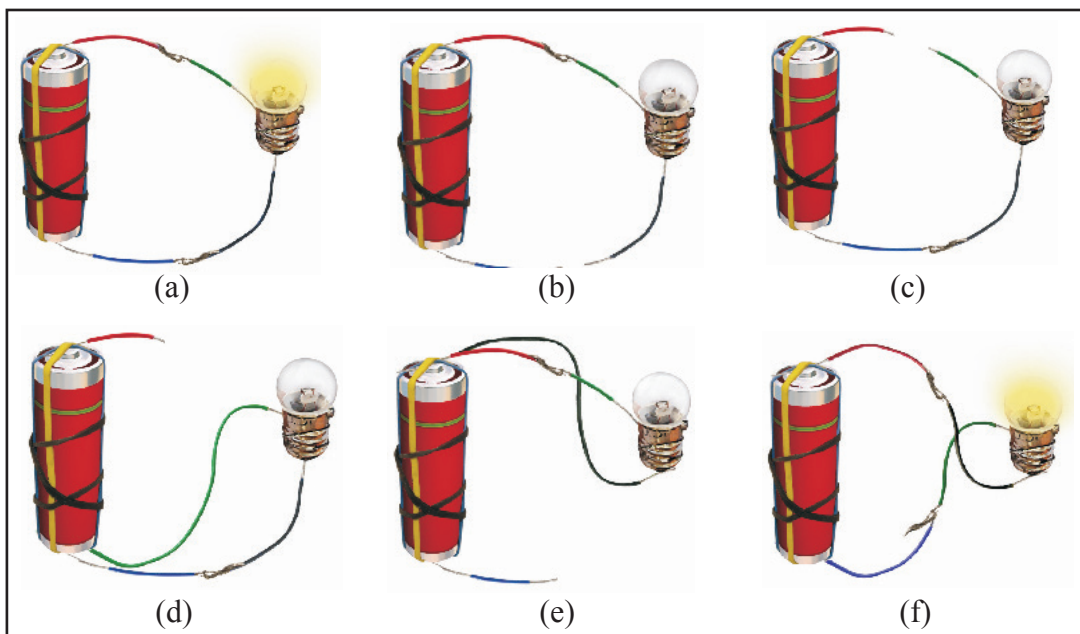

Fig 12.5 *Different arrangements of electric cell and bulb*



12.3 AN ELECTRIC CIRCUIT

In Activity 2 you connected one terminal of the electric cell to the other terminal through wires passing to and from the electric bulb. Note that in the arrangements shown in Fig. 12.5 (a) and (f), the two terminals of the electric cell were connected to two terminals of the bulb. Such an arrangement is an example of an electric circuit. The electric circuit provides a complete path for electricity to pass (current to flow) between the two terminals of the electric cell. The bulb glows only when current flows through the circuit.

In an electric circuit, the direction of current is taken to be from the positive to the negative terminal of the electric cell as shown in Fig. 12.6. When the terminals of the bulb are connected with that of the electric cell by wires, the current passes through the filament of the bulb. This makes the bulb glow.

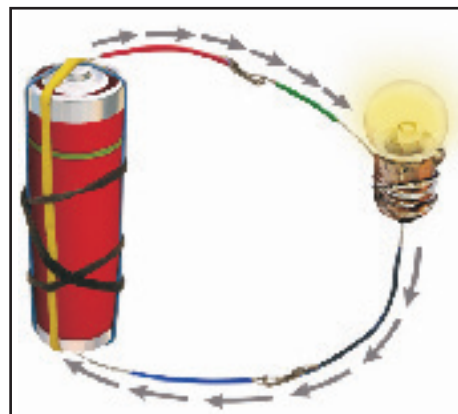

Fig 12.6 Direction of current in an electric circuit

Sometimes an electric bulb does not glow even if it is connected to the cell. This may happen if the bulb has fused. Look at a fused bulb carefully. Is the filament inside it intact?

An electric bulb may fuse due to many reasons. One reason for a bulb to fuse is a break in its filament. A break in the filament of an electric bulb means a break in the path of the current between the terminals of the electric cell. Therefore, a fused bulb does not light up as no current passes through its filament.

Can you now explain why the bulb did not glow when you tried to do so with the arrangements shown in Fig. 12.5 (b), (c), (d) and (e)?

Now we know how to make a bulb light up using an electric cell. Would you like to make a torch for yourself?

Activity 3

Take a torch bulb and a piece of wire. Remove the plastic covering at the two ends of the wire as you did before. Wrap one end of a wire around the base of an electric bulb as shown in Fig. 12.7. Fix the other end of the wire to the negative terminal of an electric cell with a rubber band. Now, bring the tip of the base of the bulb, that is, its other terminal in contact with the positive terminal of the cell. Does the bulb glow? Now move the bulb away from the terminal of the electric cell. Does the bulb remain lighted? Is this not similar to what you do when you switch your torch on or off?

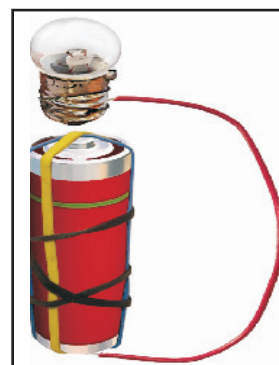

Fig 12.7 A home made torch



12.4 ELECTRIC SWITCH

We had an arrangement for switching on or off our home made torch by moving the base of the bulb away from the tip of the cell. This was a simple switch, but, not very easy to use. We can make another simple and easier switch to use in our circuit.

Activity 4

You can make a switch using two drawing pins, a safety pin (or a paper clip), two wires and a small sheet of thermo Col or a wooden board. Insert a drawing pin into the ring at one end of the safety pin and fix it on the thermo Col sheet as shown in Fig. 12.8. Make sure that the safety pin can be rotated freely. Now, fix the other drawing pin on the thermo Col sheet in a way that the free end of the safety pin can touch it. The safety pin fixed in this way would be your switch in this activity.

Now, make a circuit by connecting an electric cell and a bulb with this switch as shown in Fig.12.9. Rotate the safety pin so that its free end touches the other drawing pin. What do you observe? Now, move the safety pin away. Does the bulb continue to glow?

The safety pin covered the gap between the drawing pins when you made it touch two of them. In this position the switch is said to be ‘on’ (Fig. 12.10). Since the material of the safety pin allows the current to pass through it, the circuit was complete. Hence, the bulb glows.

On the other hand, the bulb did not glow when the safety pin was not in touch with the other drawing pin. The circuit was not complete as there was a gap between the two drawing pins. In this position, the switch is said to be ‘off’ as in Fig. 12.9.

A switch is a simple device that either breaks the circuit or completes it. The switches used in lighting of electric bulbs and other devices in homes work on the same principle although their designs are more complex.



Fig 12.8 A simple switch with a switch

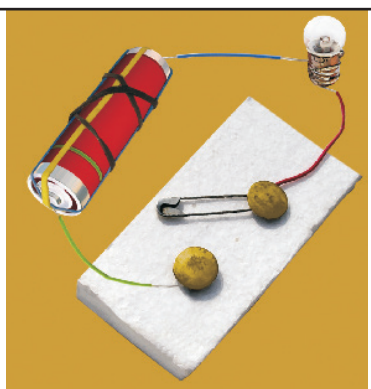

Fig 12.9 An electric circuit position

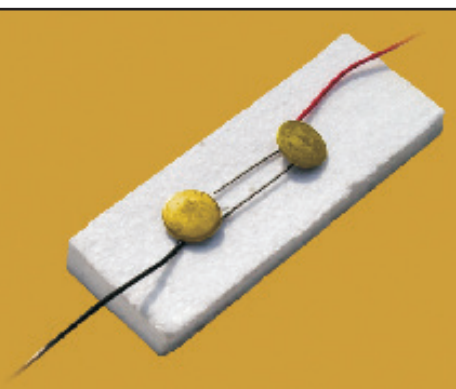

Fig 12.10 A switch in ‘on’



12.5 ELECTRIC CONDUCTORS AND INSULATORS

In all our activities we have used metal wires to make a circuit. Suppose we use a cotton thread instead of a metal wire to make a circuit. Do you think that the bulb will light up in such a circuit? What materials can be used in electric circuits so that the current can pass through them? Let us find out.

Activity 5

Disconnect the switch from the electric circuit you used for Activity 4. This would leave you with two free ends of wires as shown in Fig. 12.11 (a). Bring the free ends of the two wires close, to let them touch each other. Does the bulb light up? You can now use this arrangement to test whether any given material allows current to pass through it or not.

Collect samples of different types of materials such as coins, cork, rubber, glass, keys, pins, plastic scale, wooden block, pencil lead, aluminium foil, candle, sewing needle, thermocol, paper and pencil lead. One by one bring the free ends of the wires of your tester in contact with two ends of the samples you have collected [Fig. 12.11 (b)]. Make sure that the two wires do not touch each other while you are doing so. Does the bulb glow in each case?

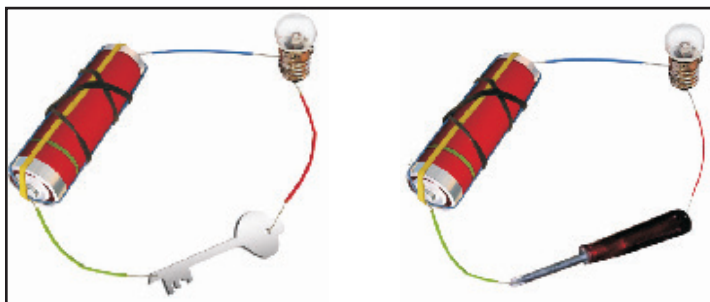

Fig 12.11 (a) a Conduction tester (b) Testing whether the bulb glows when the tester is in contact with a key

Make a table in your notebook similar to Table.12.1, and record your observations.

Table 12.1 Conductors and insulators

Object used in place of the switch	Material it is made of	Bulb glows? (yes/no)
Key	Metal	Yes
Eraser	Rubber	No
Scale	Plastic	
Matchstick	Wood	
Glass bangle	Glass	
Iron nail	Metal	



What do you find? The bulb does not glow when the free ends of the wires are in contact with some of the materials you have tested. This means that these materials do not allow the electric current to pass through them. On the other hand, some materials allow electric current to pass through them, which is indicated by the glowing bulb. Materials which allow electric current to pass through them are conductors of electricity. Insulators do not allow electric current to pass through them. With the help of Table 12.1; name the materials that are conductors of electricity and also those which are insulators.

Conductors _____, _____, _____

Insulator _____, _____, _____

What do you conclude? Which materials are conductors and which are insulators? Recall the objects that we grouped as those having lustre, in Chapter 4. Are they the conductors? It now seems easy to understand why copper, aluminum and other metals are used for making wires.

Let us recall Activity 4 in which we made an electric circuit with a switch (Fig.12.9). When the switch was in the open position, were the two drawing pins not connected with each other through the thermo Col sheet? But, thermo Col, you may have found is an insulator. What about the air between the gap? Since the bulb does not glow when there is only air in the gap between the drawing pins in your switch, it means that air is also an insulator.

Conductors and insulators are equally important for us. Switches, electrical plugs and sockets are made of conductors. On the other hand, rubber and plastics are used for covering electrical wires, plug tops, switches and other parts of electrical appliances, which people might touch.



What You have Learnt

- Electric cell is a source of electricity.
- An electric cell has two terminals; one is called positive (+ ve) while the other is negative (- ve).
- An electric bulb has a filament that is connected to its terminals.
- An electric bulb glows when electric current passes through it.
- In a closed electric circuit, the electric current passes from one terminal of the electric cell to the other terminal.
- Switch is a simple device that is used to either break the electric circuit or to complete it.
- Materials that allow electric current to pass through them are called conductors.
- Materials that do not allow electric current to pass through them are called insulators.



Exercises

- Fill in the blanks :
 - A device that is used to break an electric circuit is called _____.
 - An electric cell has _____ terminals.
- Mark 'True' or 'False' for following statements:
 - Electric current can flow through metals.
 - Instead of metal wires, a jute string can be used to make a circuit.
 - Electric current can pass through a sheet of thermo Col.
- Explain why the bulb would not glow in the arrangement shown in Fig. 12.12

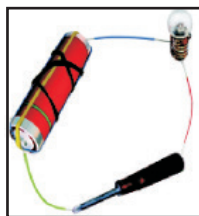

Fig 12.12

- Complete the drawing shown in Fig 12.14 to indicate where the free ends of the two wires should be joined to make the bulb glow.

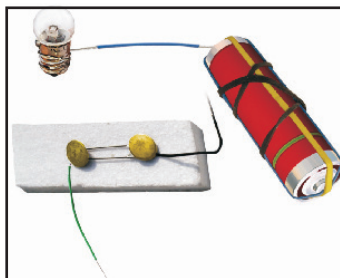

Fig 12.13

- What is the purpose of using an electric switch? Name some electrical gadgets that have switches built into them.
- Would the bulb glow after completing the circuit shown in Fig. 12.13 if instead of safety pin we use an eraser?
- Would the bulb glow in the circuit shown in Fig. 12.14?

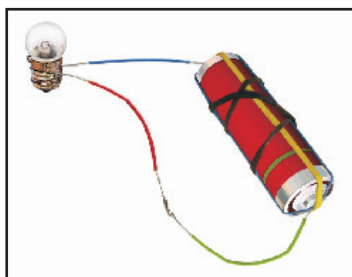

Fig 12.14

8. Using the “conduction tester” on an object it was found that the bulb begins to glow. Is that object a conductor or an insulator? Explain.
9. Why should an electrician use rubber gloves while repairing an electric switch at your home? Explain.
10. The handles of the tools like screwdrivers and pliers used by electricians for repair work usually have plastic or rubber covers on them. Can you explain why?

SOME SUGGESTED ACTIVITIES

1. Imagine there were no electric supply for a month. How would that affect your day to day activities and others in your family? Present your imagination in the form of a story or a play. If possible stage the play written by you or your friends in school.
2. For your friends, you may set up a game “How steady is your hand?”. You will need a cell, an electric bulb, a metal key, two iron nails (about 5 cm in length), about one and a half metre long thick metal wire (with its plastic insulation scraped off) and few pieces of connecting wires. Fix two nails nearly one metre apart on a wooden board so that these can be used as a hook. Fix the wire between the nails after inserting it through the loop of the key. Connect one end of this wire to a bulb and a cell. Connect the other terminal of the cell to the key with a wire. Ask your friend to move the loop along the straight wire without touching it. Glowing of the bulb would indicate that the loop of the key has touched the wire.
3. Read and find out about Alessandro Volta who invented the electric cell. You may also find out about Thomas Alva Edison who invented the electric bulb.



Fun with Magnets

Keywords : Compass, Magnetism, Horse-shoe magnet

While going through the markets you might have observed a man carrying an iron rod which rolls along the road and after sometime, the man cleaning that iron rod of the stuck material in the form of iron nails, iron made objects. The man carrying that iron rod is nothing but a magnet which has attracted the iron objects spread over the road. In larger cities, a crane usually searches for something in a heap of junk, with its long neck. Then after sometime many pieces of iron are seen sticking to this end. What is the thing that attracts iron objects? Yes, a magnet.



Fig 13.1 *Picking up pieces of iron from outside*

You might have seen magnets and have even enjoyed playing with them. Have you seen stickers that remain attached to iron surfaces like almirahs or the doors of refrigerators? In some pin holders, the pins seem to be sticking to the holder. In some pencil boxes, the lid fits tightly when we close it even without a locking arrangement. Such stickers, pin holders and pencil boxes have magnets fitted inside (Fig. 13.2). If you have any one of these items, try to locate the magnets hidden in these.

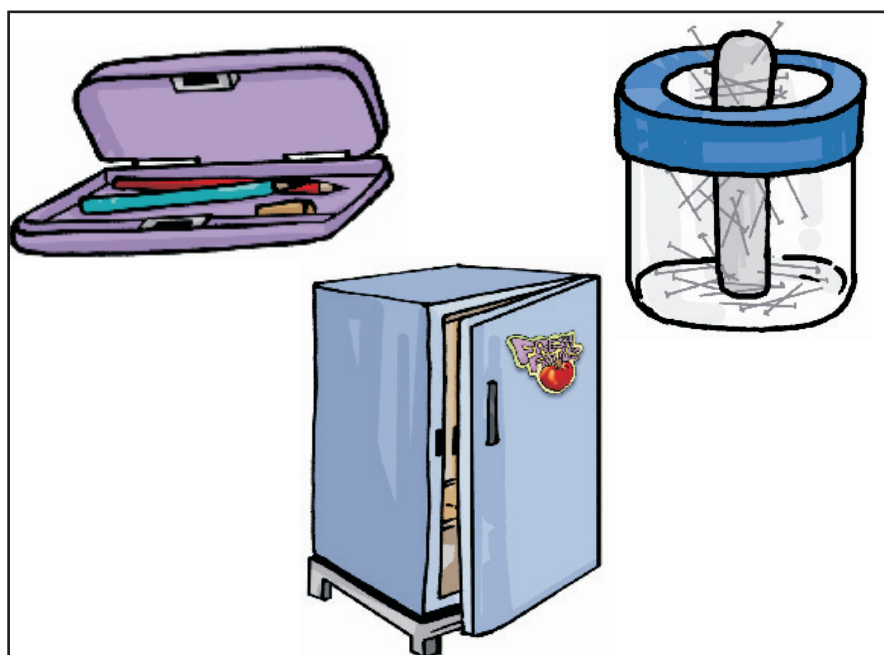

Fig 13.2 *Some common items that have magnets inside them*



How Magnets Were Discovered

It is said that, there was a shepherd named Magnes, who lived in ancient Greece. He used



Fig 13.3 A natural magnet on a hill side

to take his herd of sheep and goats to the nearby mountains for grazing. He would take a stick with him to control his herd. The stick had a small piece of iron attached at one end. One day he was surprised to find that he had to pull hard to free his stick from a rock on the mountainside (Fig. 13.3). It seemed as if the stick was being attracted by the rock. The rock was a natural magnet and it attracted the iron tip of the shepherd's stick. It is said that this is how natural magnets were discovered. Such rocks were given the name magnetite, perhaps after the name of that shepherd. Magnetite contains iron. Some people believe that magnetite was first discovered at a place called Magnesia. The substances having the property of attracting iron are now known as magnets. This is how the story goes.

In any case, people now have discovered that certain rocks have the property of attracting pieces of iron. They also found that small pieces of these rocks have some special properties. They named these naturally occurring materials magnets. Later on the process of making magnets from pieces of iron was discovered. These are known as artificial magnets. Nowadays artificial magnets are prepared in different shapes. For example, bar magnet, horse-shoe magnet, cylindrical or a ball-ended magnet. Fig.13.4 shows a few such magnets.

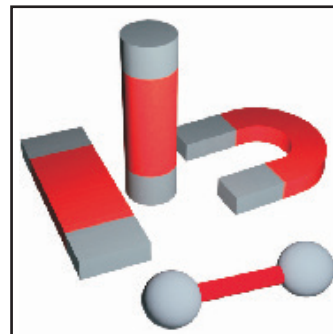

Fig 13.4 Magnets of different shapes

Activity 1

Take a plastic or a paper cup. Fix it on a stand with the help

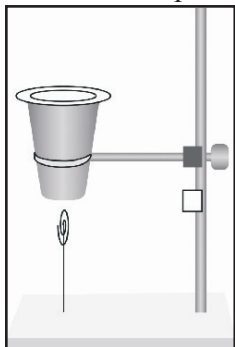

Fig 13.5 Effect of magnet-a paper clip hanging in air

of a clamp as shown in Fig. 13.5. Place a magnet inside the cup and cover it with a paper so that the magnet is not visible. Attach a thread to a clip made of iron. Fix the other end of the thread at the base of the stand. (Mind you, the trick involved here, is to keep the length of the thread sufficiently short.) Bring the clip near the base of the cup. The clip is raised in air without support, like a kite.

13.1 MAGNETIC AND NON-MAGNETIC MATERIALS

Activity 2

Let us walk in the footsteps of Magnets. Only, this time, we will change the positions of the magnet and the iron. There will be a magnet at



the end of our shepherd's stick. We can attach a small magnet to a hockey stick, walking stick or a cricket wicket with a tape or some glue. Let us now go out on a "Magnets walk" through the school playground. What does our "Magnets stick" pick up from the school ground? What about objects in the classroom?

Collect various objects of day-to-day use from your surroundings. Test these with the "Magnets stick". You can also take a magnet, touch these objects with it and observe which objects stick to the magnet. Prepare a table in your notebook as shown in Table 13.1. and record your observations.

Look at the last column of Table 13.1 and note the objects that are attracted by a magnet. Now, make a list of materials from which these objects are made. Is there any material common in all the objects that were attracted by the magnet?

We understand that magnet attracts certain materials whereas some do not get attracted towards magnet. The materials which get attracted towards a magnet are magnetic – for example, iron, nickel or cobalt. The materials which are not attracted towards a magnet are non-magnetic. What materials did you find to be non-magnetic from Table 13.1? Is soil a magnetic or a non-magnetic material?

Table 13.1 Finding the objects attracted by magnet

Name of the object	Material which the object is made of (cloth/plastic/aluminium/wood/glass/iron /any other	Attracted by magnets Stick/magnet (Yes /No)

Activity 3

Rub a magnet in the sand or soil. Pull out the magnet. Are there some particles of sand or soil sticking to the magnet? Now, gently shake the magnet to remove the particles of sand or soil. Are some particles still sticking to it? These might be small pieces of iron (iron filings) picked up from the soil.

Through such an activity, we can find out whether the soil or sand from a given place contains particles that have iron. Try this activity near your home, school or the places you visit on your holidays. Does the magnet with iron filings sticking to it, look like any one of those shown in Fig. 13.6?

Make a table of what you find.

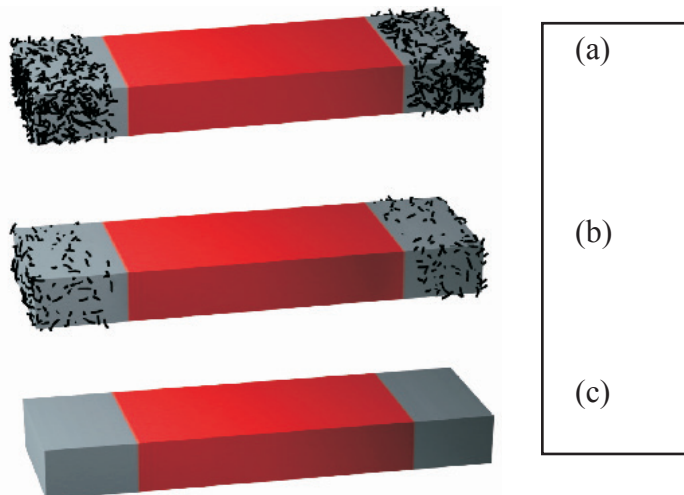

Fig 13.6 Magnet with (a) many iron fillings (b) few iron fillings (c) no iron fillings sticking to it

Table 13.2 Magnet rubbed in sand. How many iron fillings

Name of location (Colony and town/city/village)	Did you find iron fillings sticking to the magnet?(Many/very/few/none)

13.2 POLES OF MAGNET

We observed that iron filings (if they are present) stick to a magnet rubbed in the soil. Did you observe anything special about the way they stick to the magnet?

Activity 4

Spread some iron filings on a sheet of paper. Now, place a bar magnet on this sheet. What do you observe? Do the iron filings stick all over the magnet? Do you observe that more iron filings get attracted to some parts of the magnet than others (Fig. 13.7)? Remove the iron filings sticking to the magnet and repeat the activity. Do you observe any change in the pattern with which the iron filings get attracted by different parts of the magnet? You can do this activity using pins or iron nails in place of iron filings and also with magnets of different shapes.

Draw a diagram to show the way iron filings stick to the magnet. Is your drawing similar to that shown in Fig. 13.6 (a)?



We find that the iron filings are attracted more towards the region close to two ends of a bar magnet. Poles of a magnet are said to be near these ends. Try and bring a few magnets of different shapes to the classroom. Check for the location of the poles on these magnets using iron filings. Can you now mark the location of poles in the kind of magnets shown in Fig. 13.4?



Fig 13.7 iron filings sticking to a bar magnet

13.3 FINDING DIRECTIONS

Magnets were known to people from ancient times. Many properties of magnets were also known to them. You might have read many interesting stories about the uses of magnets. One such story is about an emperor in China named Hoang Ti. It is said that he had a chariot with a statue of a lady that could rotate in any direction. It had an extended arm as if it was showing the way (Fig. 13.8). The statue had an interesting property. It would rest in such a position that its extended arm always pointed towards South. By looking at the extended arm of the statue, the Emperor was able to locate directions when he went to new places on his chariot.

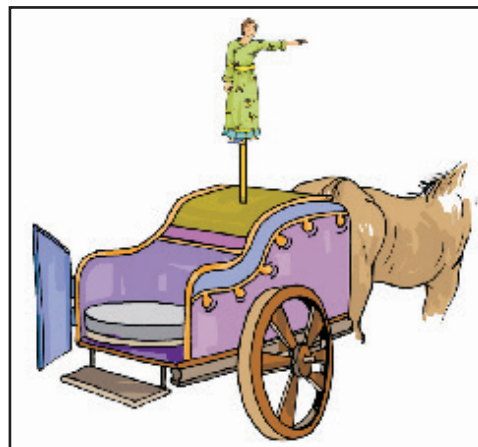

Fig 13.8 The chariot with direction finding statue

Let us make such a direction finder for ourselves.

Activity 5

Take a bar magnet. Put a mark on one of its ends for identification. Now, tie a thread at the middle of the magnet so that you may suspend it from a wooden stand (Fig. 13.9). Make sure that the magnet can rotate freely. Let it come to rest. Mark two points on the ground to show the position of the ends of the magnet when it comes to rest. Draw a line joining the two points. This line shows the direction in which the magnet was pointing in its position of rest. Now, rotate the magnet by gently pushing one end in any direction and let it come to rest. Again, mark the position of the two ends in its position of rest. Does the magnet now point in a different direction? Rotate the magnet in other directions and note the final direction in which it comes to rest.



Fig 13.9 *A freely suspended bar magnet always comes to rest in the same direction*

Do you find that the magnet always comes to rest in the same direction? Now can you guess the mystery behind the statue in the Emperor's chariot?

Repeat this activity with an iron bar and a plastic or a wooden scale instead of a magnet. Do not use light objects for this activity and avoid doing it where there are currents of air. Do the other materials also always come to rest in the same direction?

We find that a freely suspended bar magnet always comes to rest in a particular direction, which is the North-South direction. Use the direction of the rising sun in the morning to find out the rough direction towards east, where you are doing this experiment. If you stand facing east, to your left will be North. Using the Sun for finding directions may not be very exact, but, it will help to make out the direction North from the South, on your line. Using this you can figure out which end of the magnet is pointing to the North and which points to the South.

The end of the magnet that points towards North is called its North seeking end or the North pole of the magnet. The other end that points towards the South is called South seeking end or the South pole of the magnet. All magnets have two poles whatever their shape may be. Usually, north (N) and south (S) poles are marked on the magnets.

This property of the magnet is very useful for us. For centuries, travellers have been making use of this property of magnets to find directions. It is said that in olden days, travellers used to find directions by suspending natural magnets with a thread, which they always carried with them.



Later on, a device was developed based on this property of magnets. It is known as the compass. A compass is usually a small box with a glass cover on it. A magnetised needle is pivoted inside the box, which can rotate freely (Fig. 13.10). The compass also has a dial with directions marked on it. The compass is kept at the place where we wish to know the directions. Its needle indicates the north-south direction when it comes to rest. The compass is then rotated until the north and south marked on the dial are at the two ends of the needle. To identify the north-pole of the magnetic needle, it is usually painted in a different colour.



Fig 13.10 A compass

13.4 MAKE YOUR OWN MAGNET

There are several methods of making magnets. Let us learn the simplest one. Take a rectangular piece of iron. Place it on the table. Now take a bar magnet and place one of its poles near one edge of the bar of iron. Without lifting the bar magnet, move it along the length of the iron bar till you reach the other end. Now, lift the magnet and bring the pole (the same pole you started with) to the same point of the iron bar from which you began (Fig. 13.11). Move the magnet again along the iron bar in the same direction as you did before. Repeat this process about 30-40 times. Bring a pin or some iron filings near the iron bar to check whether it has become a magnet. If not, continue the process for some more time. Remember that the pole of the magnet and the direction of its movement should not change. You can also use an iron nail, a needle or a blade and convert them into a magnet.

You now know how to make a magnet. Would you like to make your own compass?

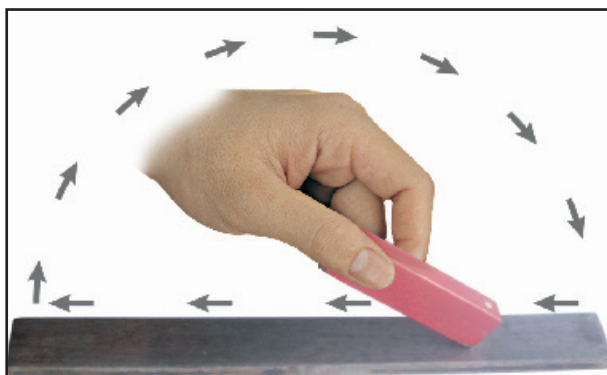

Fig 13.11 Making your own magnet

Activity 6

Magnetise an iron needle using a bar magnet. Now, insert the magnetised needle through a small piece of cork or foam. Let the cork float in water in a bowl or a tub. Make sure that the needle does not touch the water your compass is now ready to work. Make a note of the direction in which the needle points when the cork is floating. Rotate the cork, with the needle fixed in it,



in different directions. Note the direction in which the needle points when the cork begins to float again without rotating. Does the needle always point in the same direction, when the cork stops rotating?

13.5 ATTRACTION AND REPULSION BETWEEN MAGNETS

Let us play another interesting game with magnets. Take two small toy cars and label them A and B. Place a bar magnet on top of each car along its length and fix them with rubber bands (Fig. 13.12). In car A, keep the south pole of the magnet towards its front. Place the magnet in opposite direction in car B. Now, place the two cars close to one another (Fig. 13.13). What do you observe? Do the cars remain at their places? Do the cars run away from each other? Do they move towards each other and collide? Record your observations in a table as shown in Table 13.3. Now, place the toy cars close to each other such that the rear side of car A faces the front side of car B (Fig 13.13). Do they move as before? Note the direction in which the cars move now. Next, place the car A behind car B and note the direction in which they move in each case. Repeat the activity by placing cars with their rear sides facing each other. Record your observations in each case.

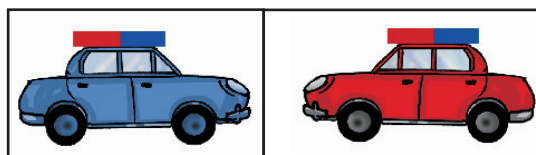

Fig 13.12 Do opposite poles attract each other?

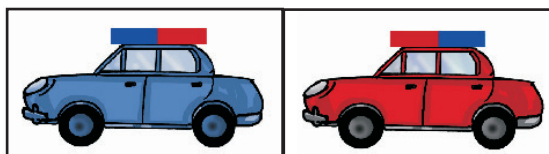

Fig 13.13 Repulsion between similar poles

Table 13.3

Position of the cars	How do the cars move/ Move towards/ away from each other/not move at all
Front of car A facing the front of car B	
Rear of car facing the front of car B	
Car A placed behind car B	
Rear of car b facing rear of car A	

What do we find from this activity? Do two similar poles attract or repel each other? What about opposite poles — do they attract or repel each other?

This property of the magnets can also be observed by suspending a magnet and bringing one by one the poles of another magnet near it.

A Few Cautions

Magnets lose their properties if they are heated, hammered or dropped from some height (Fig. 13.14). Also, magnets become weak if they are not stored properly. To keep them safe, bar magnets should be kept in pairs with their unlike poles on the same side. They must be separated



by a piece of wood while two pieces of soft iron should be placed across their ends (Fig. 13.15). For horse-shoe magnet, one should keep a piece of iron across the poles.

Keep magnets away from cassettes, mobiles, television, music system, compact disks (CDs) and the computer.

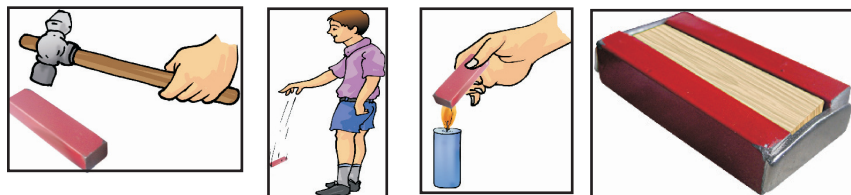

Fig 13.14 Magnets lose their property on heating hammering and dropping

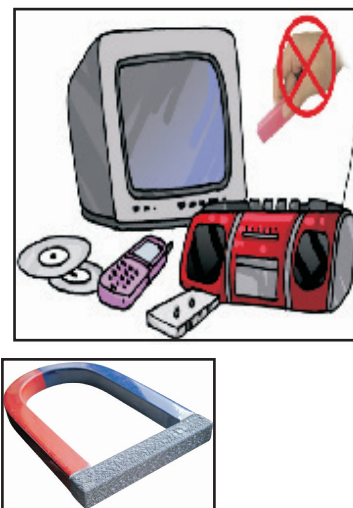

Fig 13.15 Store your magnets safely



What You have Learnt

- Magnetite is a natural magnet.
- Magnet attracts materials like iron, nickel, cobalt. These are called magnetic materials.
- Materials that are not attracted towards magnet are called non-magnetic.
- Each magnet has two magnetic poles—North and South.
- A freely suspended magnet always aligns in N-S direction.
- Opposite poles of two magnets attract each other whereas similar poles repel one another.



Exercises

- Fill in the blanks in the following
 - Artificial magnets are made in different shapes such as _____, _____ and _____.
 - The Materials which are attracted towards a magnet are called _____.
 - Paper is not a _____ material.
 - In olden days, sailors used to find direction by suspending a piece of _____.



- v. A magnet always has _____ poles.
 - vi. A compass helps in determining the direction of _____.
 - vii. Magnetic _____ exists in pairs.
 - viii. Like poles of magnet ____ each other.
2. State whether the following statements are true or false
- i. A cylindrical magnet has only one pole.
 - ii. Artificial magnets were discovered in Greece.
 - iii. Similar poles of a magnet repel each other.
 - iv. Maximum iron filings stick in the middle of a bar magnet when it is brought near them.
 - v. Bar magnets always point towards North-South direction.
 - vi. A compass can be used to find East-West direction at any place.
 - vii. Rubber is a magnetic material.
3. It was observed that a pencil sharpener gets attracted by both the poles of a magnet although its body is made of plastic. Name a material that might have been used to make some part of it.
4. Column I shows different positions in which one pole of a magnet is placed near that of the other. Column II indicates the resulting action between them for each situation. Fill in the blanks.
- | | |
|----------|------------|
| Column I | Column II |
| N-N | _____ |
| N- _____ | Attraction |
| S-N | _____ |
| _____ -S | Repulsion |
- 5. Write any two properties of a magnet.
 - 6. Where are poles of a bar magnet located?
 - 7. A bar magnet has no markings to indicate its poles. How would you find out near which end is its north pole located?
 - 8. You are given an iron strip. How will you make it into a magnet?
 - 9. How is a compass used to find directions?
 - 10. A magnet was brought from different directions towards a toy boat that



has been floating in water in a tub. Affect observed in each case is stated in Column I. Possible reasons for the observed affects are mentioned in Column II. Match the statements given in Column I with those in Column II.

Column I

Boat gets attracted towards the magnet

Boat is not affected by the magnet

Boat moves towards the magnet if north Pole of the magnet is brought near it's dead.

Boat moves away from the magnet when North pole is brought near its end.

Boat floats without changing its direction.

Column II

Boat is fitted with a magnet with North Pole towards its head.

Boat is fitted with a magnet with South Pole towards its head.

Boat has a small magnet fixed along its length.

Boat is made of magnetic material.

Boat is made of non-magnetic material.

SOME SUGGESTED ACTIVITIES

1. What will happen if a magnet is brought near a compass?
2. Using a compass, find the direction in which windows and entrance to your house or class room open.
3. Try to place two equal sized bar magnets one above the other such that their north poles are on the same side. Note what happens and write your observations in your note book.
4. Few iron nails and screws got mixed with the wooden shavings while a carpenter was working with them. How can you help him in getting the nails and screws back from the scrap without wasting his time in searching with his hands?
5. You can make an intelligent doll, which picks up the things it likes. Take a doll and attach a small magnet in one of its hands. Cover this hand with small gloves so that the magnet is not visible. Now, your intelligent doll is ready. Ask your friends to bring different objects near the doll's hand. Knowing the material of the object you can tell in advance whether the doll would catch it or not.



Water

Keywords : Saline, Evaporation, Transpiration, Conservation, Harvesting

Water is the most wonderful gift from nature. It supports life on earth. Life is impossible without water. Living things can survive without food for weeks but not without water. This shows the importance of water for the living beings.

Water is an essential requirement of all the life. We too require it for our daily life activities.

Suppose for some reason your family gets only one bucket of water everyday for a week. Imagine what would happen? Would you be able to cook, clean utensils, wash clothes or bathe? What are the other activities you would not be able to do? What would happen if we do not have easy access to water for a long period of time?

Apart from drinking, there are so many activities for which we use water (Fig. 14.1). Do you have an idea about the quantity of water we use in a single day?



Fig 14.1 *Uses of water*

Do You Know?

Nearly 70% of our body is water and it being lost every moment by our breath sweat and urination.

14.1 HOW MUCH WATER DO WE USE?

Activity 1

List all the activities for which you use water in a day. Some activities are listed in Table 14.1. Make a similar table in your notebook. Throughout the day, measure the amount of water used for each activity by you and other family members. You may use a mug, a glass, a bucket or any other container to measure the amount of water used.

Table 14.1 *Estimation of the amount of water used by a family in a day*

Activity	Amount of water used
Drinking	
Brushing	
Bathing	
Washing utensils	
Washing clothes	
Toilets	
Cleaning floor	
Any other	
Total water used in a day by a family	



You now have a rough idea as to how much water your family uses in a day. Using this information, calculate the amount of water needed by your family in a year. Now, divide this amount by the number of members of your family. This will give an idea of the amount of water needed by one member of your family in a year. Find the number of people that live in your village or town. You may now get an idea of the amount of water needed by your village or town in a year.

You have listed a number of activities for which you use water. Do you think, our water requirement is limited to activities like these? We use wheat, rice, pulses, vegetables and many other food items everyday. We know that some of the fibres that we use for making fabric come from plants. Is water not needed to grow these? Can you think of some more uses of water? Water is used in industries for producing almost all the things that we use. So, we need water not only for our daily activities but also for producing many things.

14.2 WHERE DO WE GET WATER FROM?

Where do you get the water that you use? Some of you may say, “We draw water from a river, spring, pond, well or a hand pump”. Some others might say, “We get water from taps”. Have you ever wondered where water in the taps comes from? Water that we get from taps is also drawn from a lake or a river or a well (Fig. 14.2). It is then supplied through a network of pipes.

Each of us may be getting water into our homes in different ways. But, finally, all of us get water from the same sources such as ponds, lakes, rivers and wells.

We have discussed some of the sources of water. Where does the water come from, to fill these ponds, lakes, rivers and wells?

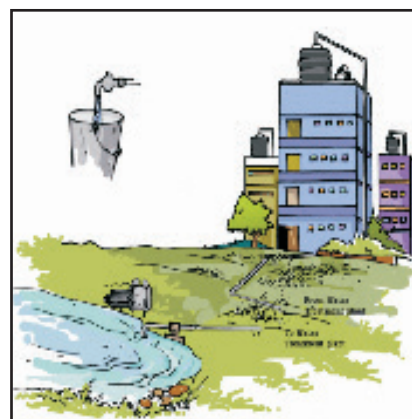

Fig 14.2 Water in taps comes from rivers, lakes or wells

Do you know that about two thirds of the Earth is covered with water? Most of this water is in oceans and seas (Fig. 14.3).

The water in the oceans and seas has many salts dissolved in it — the water is saline. So, it is not fit for drinking and other domestic, agricultural and industrial needs. You might have heard the famous lines of the poem “Rime of the Ancient Mariner” written by S.T. Coleridge in 1798:



Fig 14.3 Oceans cover a major part of the earth

*“Water water every where
Nor any drop to drink”*

Here the poet has described the plight of sailors on a ship lost in the ocean.

Yet, oceans play an important role in supplying the water that we use. Do you find this



surprising? After all, the water that we use is not salty. Many of us live in places far away from the oceans. Does the water supply in these places also depend on the oceans? How does the ocean water reach ponds, lakes, rivers and wells, which supply us water? How come the water from these sources is not saline anymore?

That is where the water cycle comes in!

14.3 WATER CYCLE

Disappearing Trick of Water

How many times have you noticed that water spilled on a floor dries up after some time? The water seems to disappear. Similarly, water disappears from wet clothes as they dry up (Fig. 14.4). Water from wet roads, rooftops and a few other places also disappears after the rains. Where does this water go?

Do you remember Activity 6 in Chapter 5 in which water with salt dissolved in it was heated? What did we find? The water evaporated and the salt was left behind. This activity gives us an idea that, on heating, water changes into its vapour. We also realise from this activity, that water vapour does not carry away the salt with it. Water vapours so formed become a part of the air and cannot usually be seen. We also found that heating is essential to convert water into its vapour. However, we have seen that water changes into its vapour also from the fields, roads, rooftops and other land areas. We also discussed in Chapter 5 that to obtain salt, water from the sea is left in shallow pits to let the water evaporate. From where does this water get the heat it needs to evaporate? Let us find out.

Activity 2

Take two similar plates. Place one of the plates in sunlight and keep the other under shade. Now, pour equal amount of water in each of the plates (Fig. 14.5). You can use a cap of a bottle to measure water. Make sure that water does not spill over. Observe the two plates after every 15 minutes. Does the water seem to disappear? From which plate does it disappear first? What is the source of heat for this evaporation?

During the daytime, sunlight falls on the water in oceans, rivers, lakes and ponds. The fields and other land areas also receive sunlight. As a result, water from all these places continuously changes into

Do You know

It is found that nearly 500 liters of water are lost during transpiration by wheat plants which give us one kilogram of

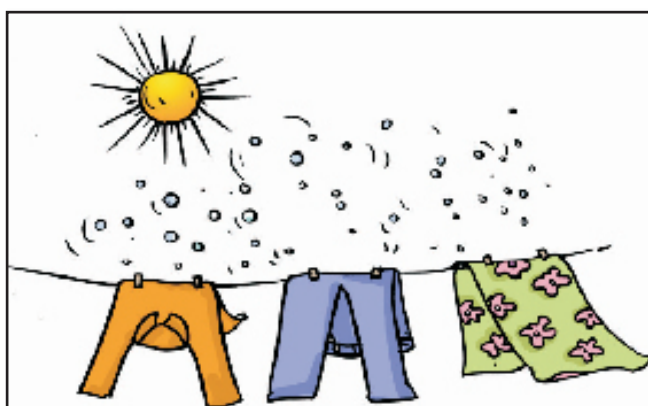

Fig 14.4 Clothes drying on a clothes line

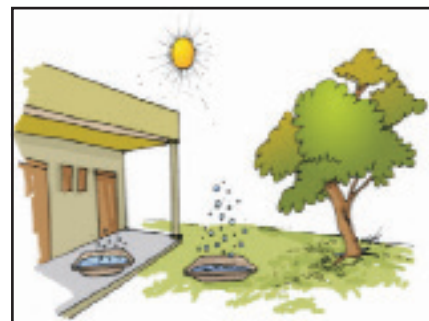

Fig 14.5 Evaporation of water in sunlight and in shade



vapour. However, the salts dissolved in the water are left behind.

In Activity 2, did you find that water also disappeared from the plate kept in the shade, though it could have taken more time? Does the heat from the sunlight reach here? Yes, during the daytime all the air surrounding us gets heated. This warm air provides heat for evaporation of water in the shade. Thus, evaporation takes place from all open surfaces of water. As a result, water vapour gets continuously added to air. However, evaporation of water is a slow process. That is why we rarely notice its loss from a bucket full of water. In sunlight, evaporation takes place faster. On heating water on a burner, its evaporation takes place even faster. Is there any other process through which water vapour gets transferred into air?

Loss of Water by Plants

You have learnt in Chapter 7 that plants need water to grow. Plants use a part of this water to prepare their food and retain some of it in their different parts. Remaining part of this water is released by the plants into air, as water vapour through the process of transpiration. Do you remember observing transpiration of water by plants in Activity 4 in Chapter 7?

Water vapour enters the air through the processes of evaporation and transpiration. Is it lost for ever? No, we get it back again, as we will see.

How are clouds formed?

Activity 3

Take a glass half filled with water. Wipe the glass from the outside with a clean piece of cloth. Add some ice into the water. Wait for one or two minutes. Observe the changes that take place on the outer surface of the glass (Fig. 14.6).

From where do water drops appear on the outer side of the glass? The cold surface of the glass containing iced water, cools the air around it, and the water vapour of the air condenses on the surface of the glass. We noticed this process of condensation in Activity 7 in Chapter 5.

The process of condensation plays an important role in bringing water back to the surface of earth. How does it happen? As we go higher from the surface of the earth, it gets cooler. When the air moves up, it gets cooler and cooler. At sufficient heights, the air becomes so cool that the water vapour present in it condenses to form tiny drops of water called droplets. It is these tiny droplets that remain floating in air and appear to us as clouds (Fig. 14.7).

It so happens that many droplets of water come together to form larger sized drops of water. Some drops of water become so heavy that they begin to fall. These falling water-drops are what we call rain. In special conditions, it may also fall as hail or snow.



Fig 14.6 Drops of water appear on outer surface of glass containing water with ice



Thus, water in the form of vapour goes into air by evaporation and transpiration, forms clouds, and then comes back to the ground as rain, hail or snow.



Fig 14.7 Clouds

14.4 BACK TO THE OCEANS

What happens to the water that rain and snow bring to different regions of earth? Almost all land surfaces are above the level of oceans.



Fig 14.8 Rain water flows down in the form of streams and rivers

Most of the water that falls on the land as rain and snow sooner or later goes back to the oceans. This happens in many ways.

Snow in the mountains melts into water. This water flows down the mountains in the form of streams and rivers (Fig. 14.8). Some of the water that falls on land as rain, also flows in the form of rivers and streams. Most of the rivers cover long distances on land and ultimately fall into a sea or an ocean. However, water of some rivers flows into lakes.

The rainwater also fills up the lakes and ponds. A part of the rainwater gets absorbed by the ground and seems to disappear in the soil. Some of this water is brought back to the air by the process of evaporation and transpiration. The rest seeps into the ground. Most of this water becomes available to us as ground water. Open wells are fed by ground water. Ground water is the source for many lakes as well. It is also this ground water which is drawn by a hand pump or a tube well. The more hand pumps or tube wells that are used in an area, the deeper we need to dig to find this ground water. The loss in the level of ground water due to over use, is worrisome.

In those areas where the land has little or no vegetation, the rainwater flows away quickly. Flowing rainwater also takes the top layer of the soil away with it. There are few areas where most of the land is covered with concrete. This reduces the seepage of rainwater into the ground which ultimately affects the availability of ground water.

We now know that water brought back to the surface of the earth by rain, hail or snow, goes back to oceans. Thus, water from the ocean and surface of the earth goes into air as vapour; returns as rain, hail or snow and finally goes back to the oceans. The circulation of water in this manner is known as the water cycle (Fig.14.9).

This circulation of water between ocean and land is a continuous process. This maintains the supply of water on land.

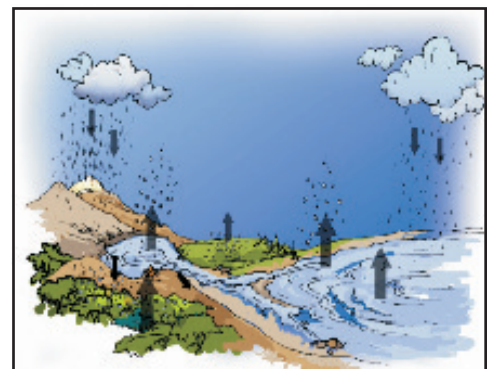

Fig 14.9 Water cycle



14.5 WHAT IF IT RAINS HEAVILY?

The time, duration and the amount of rainfall varies from place to place. In some parts of the world it rains throughout the year while there are places where it rains only for a few days. In our country, most of the rainfall occurs during the monsoon season. Rains bring relief especially after hot summer days. The sowing of many crops depends on the arrival of monsoon.

However, excess of rainfall may lead to many problems (Fig. 14.10). Heavy rains may lead to rise in the level of water in rivers, lakes and ponds. The water may then spread over large areas causing floods. The crop fields, forests, villages, and cities may get submerged by water (Fig. 14.11). In our country, floods cause extensive damage to crops, domestic animals, property and human life.



Fig 14.10 A scene after heavy rains



Fig 14.11 A scene of a flooded area

During floods, the animals living in the water also get carried away with the waters. They often get trapped on land areas and die when floodwater recedes. Rains also affect the animals living in the soil.

14.6 WHAT HAPPENS IF IT DOES NOT RAIN FOR A LONG PERIOD?

Can you imagine what would happen if it does not rain in a region for a year or more? The soil continues to lose water by evaporation and transpiration. Since it is not being brought back by rain, the soil becomes dry. The level of water in ponds and wells of the region goes down and some of them may even dry up. The ground water may also become scarce. This may lead to drought.

In drought conditions, it is difficult to get food and fodder. You might have heard about droughts occurring in some parts of our country or the world. Are you aware of the difficulties faced by the people living in these areas? What happens to the animals and the vegetation in these conditions? Try and find out about this by talking to your parents and neighbours and by reading about it from newspapers and magazines.

14.7 HOW CAN WE CONSERVE WATER?

Only a small fraction of water available on the Earth is fit for use of plants, animals and humans. Most of the water is in the oceans and it cannot be used directly. When the level of the ground



water decreases drastically, this can not be used any more. The total amount of water on Earth remains the same, but, the water available for use is very limited and is decreasing with over usage.



Fig 14.12 A queue for collecting water

The demand for water is increasing day-by-day. The number of people using water is increasing with rising population. In many cities, long queues for collection of water are a common site (Fig. 14.12). Also, more and more water is being used for producing food and by the industries. These factors are leading to shortage of water in many parts of the world. Hence, it is very important that water is used carefully. We should take care not to waste water.

14.8 RAINWATER HARVESTING

One way of increasing the availability of water is to collect rainwater and store it for later use. Collecting rainwater in this way is called rainwater harvesting. The basic idea behind rainwater harvesting is “Catch water where it falls”.

What happens to the rainwater that falls in places that are mostly covered with concrete roads and buildings? It flows into the drains, isn't it? From there water goes to rivers or lakes, which could be far away. A lot of effort will then be required to get this water back into our homes as the water did not seep into the ground.

Discussed here are two techniques of rainwater harvesting:

1. Rooftop rainwater harvesting: In this system the rainwater is collected from the rooftop to a storage tank, through pipes. This water may contain soil from the roof and need filtering before it is used. Instead of collecting rainwater in the tank, the pipes can go directly into a pit in the ground. This then seeps into the soil to recharge or refill the ground water (Fig. 14.13).
2. Another option is to allow water to go into the ground directly from the roadside drains that collect rainwater.

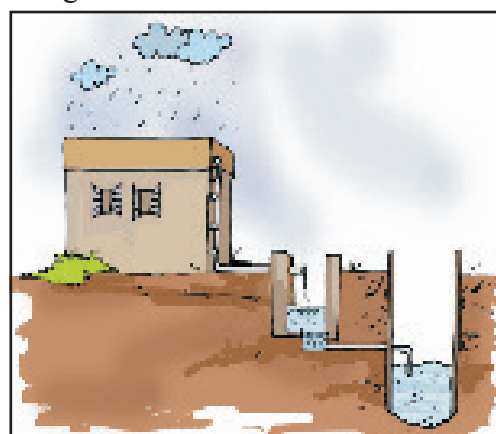

Fig 14.13 Rooftop rainwater harvesting

WATER: A PRECIOUS RESOURCE! WE SHOULD MAKE JUDICIOUS USE OF IT.



What You have Learnt

- Water is essential for life.
- Water vapour gets added to air by evaporation and transpiration.
- The water vapour in the air condenses to form tiny droplets of water, which appear as clouds. Many tiny water droplets come together and fall down as rain, snow or hail.
- Rain, hail and snow replenish water in rivers, lakes, ponds, wells and soil.
- The circulation of water between ocean and land is known as the water cycle.
- Excessive rains may cause floods while lack of it for long periods may cause droughts.
- The amount of usable water on earth is limited so it needs to be used carefully.



Exercises

1. Fill up the blanks in the following:
 - a. The process of changing of water into its vapour is called _____.
 - b. The process of changing water vapour into water is called _____.
 - c. No rainfall for a year or more may lead to _____ in that region.
 - d. Excessive rains may cause _____.
 - e. The _____ point of ice is 0°C .
 - f. Floods damage soil by causing its _____.
2. State for each of the following whether it is due to evaporation or condensation:
 - a. Water drops appear on the outer surface of a glass containing cold water.
 - b. Steam rising from wet clothes while they are ironed.



- c. Fog appearing on a cold winter morning.
 - d. Blackboard dries up after wiping it.
 - e. Steam rising from a hot girdle when water is sprinkled on it.
3. Which of the following statements are “true”?
- a. Water vapour is present in air only during the monsoon. ()
 - b. Water evaporates into air from oceans, rivers and lakes but not from the soil.()
 - c. The process of water changing into its vapour, is called evaporation.()
 - d. The evaporation of water takes place only in sunlight.()
 - e. Water vapour condenses to form tiny droplets of water in the upper layers of air where it is cooler.()
4. Suppose you want to dry your school uniform quickly. Would spreading it near an anghiti or heater help? If yes, how?
5. Take out a cooled bottle of water from refrigerator and keep it on a table. After some time you notice a puddle of water around it. Why?
6. To clean their spectacles, people often breathe out on glasses to make them wet. Explain why the glasses become wet.
7. How are clouds formed?
8. When does a drought occur?
9. Explain the formation of water cycle?
10. What do you understand by
- a. Groundwater
 - b. Running water
 - c. Rainwater harvesting



SUGGESTED PROJECTS AND ACTIVITIES

1. List three activities in which you can save water. For each activity describe how you would do it.
2. Collect pictures relating to floods or droughts from old magazines or newspapers. Paste them in your notebook and write about the problems that people would have faced.
3. Prepare a poster on ways of saving water and display it on your school notice board.
4. Write a few slogans of your own on the topic ‘Save Water’.



Air Around us.

Keywords : Winnowing, Inverted, Inter-dependence, Wind-mill

We have learnt in Chapter 9 that all living things require air.

But, have you ever seen air? You might not have seen air, but, surely you must have felt its presence in so many ways. You notice it when the leaves of the trees rustle or the clothes hanging

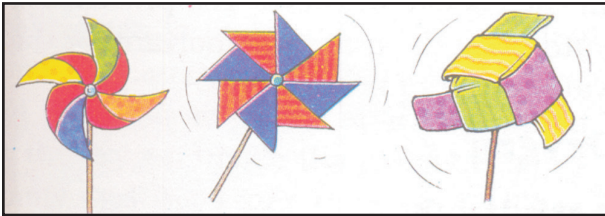

Fig 15.1 Different types of a firki

on a clothes-line sway. Pages of an open book begin fluttering when the fan is switched on. The moving air makes it possible for you to fly your kite. Do you remember Activity 3 in Chapter 5 in which you separated the sand and sawdust by winnowing? Winnowing is more effective in moving air. You may have noticed that during storms the wind blows at a very

high speed. It may even uproot trees and blow off the rooftops.

Have you ever played with a firki (Fig. 15.1)?

Activity 1

Let us make a firki of our own, following the instructions shown in Fig. 15.2.

Hold the stick of the firki and place it in different directions in an open area. Move it a little, back and forth. Observe, what happens. Does the firki rotate? What makes a firki rotate — moving air, isn't it?

Have you seen a weather cock (Fig. 15.3)? It shows the direction in which the air is moving at that place.

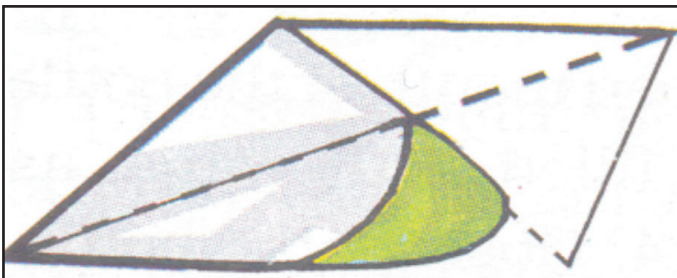

Fig 15.2 Making a simple firki

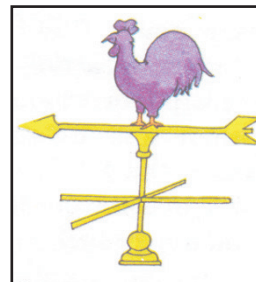

Fig 15.3 A weather cock

15.1 IS AIR PRESENT EVERYWHERE AROUND US?

Close your fist — what do you have in it? Nothing? Try the following activity to find out



Activity 2

Take an empty glass bottle. Is it really empty or does it have something inside? Turn it, upside down. Is something inside it, now?

Now, dip the open mouth of the bottle into the bucket filled with water as shown in Fig. 15.4. Observe the bottle. Does water enter the bottle? Now tilt the bottle slightly. Does the water now enter the bottle? Do you see bubbles coming out of the bottle or hear any bubbly sound? Can you now guess what was in the bottle?

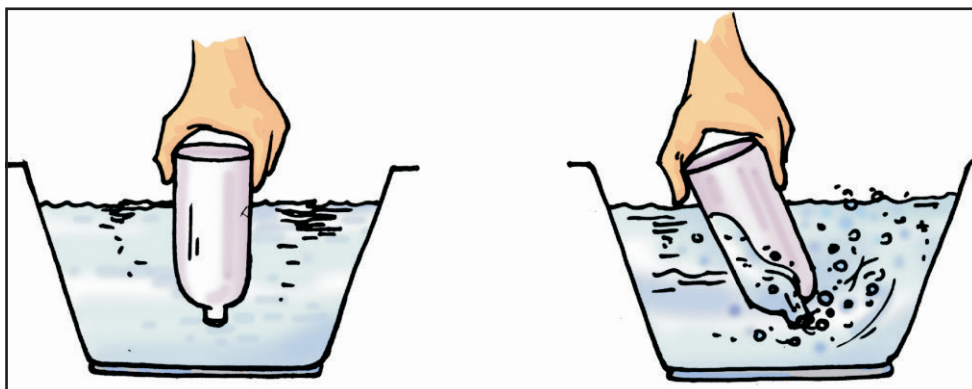

Fig 15.4 Experiments with an empty bottle

Yes! You are right. It is “air”, that was present in the bottle. The bottle was not empty at all. In fact, it was filled completely with air even when you turned it upside down. That is why you notice that water does not enter the bottle when it is pushed in an inverted position, as there was no space for air to escape. When the bottle was tilted, the air was able to come out in the form of bubbles, and water filled up the empty space that the air has occupied.

This activity shows that air occupies space. It fills all the space in the bottle. It is present everywhere around us. Air has no colour and one can see through it. It is transparent.

Our earth is surrounded by a thin layer of air. This layer extends up to many kilometres above the surface of the earth and is called atmosphere.

Why do you think, mountaineers carry oxygen cylinders with them, while climbing high mountains (Fig. 15.5)?



Fig 15.5 Mountaineers carry oxygen cylinders with them



15.2 WHAT IS AIR MADE UP OF?

Until the eighteenth century, people thought that air was just one substance. Experiments have proved that it is really not so. Air is a mixture of many gases. What kind of a mixture is it? Let us find out about some of the major components of this mixture, one by one.

Water vapour

We have learnt earlier that air contains water vapour. We also saw that, when air comes in contact with a cool surface, it condenses and drops of water appear on the cooled surfaces. The presence of water vapour in air is important for the water cycle in nature.

Oxygen

Activity 3

In the presence of your teacher, fix two small candles of the same size in the middle of two shallow containers. Now, fill the containers with some water. Light the candles and then cover each one of them with an inverted glass (one much taller than the other) as shown in Fig. 15.6. Observe carefully what happens to the burning candles and the water level.

Do the candles continue to burn or go off? Does the level of water inside glasses remain the same?

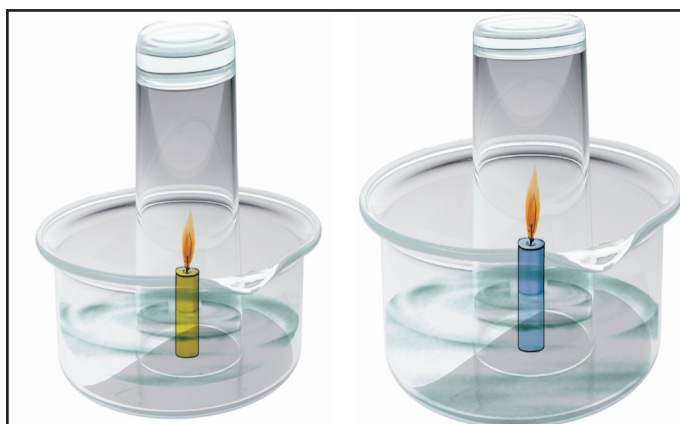

Fig 15.6 Air has oxygen

The burning of the candle must be due to presence of some component of air, isn't it? Do you find any difference in your observation with the two glasses of different heights? What can be the reason for this?

Burning can occur only in the presence of oxygen. We see that, one component of air is oxygen. Now, the amount of air and hence its oxygen component inside each glass in our experiment, is limited. When most of this oxygen is used up by the burning candle, it can no longer burn and blows out. Also, water rises up in the glass once the candle blows out. However, this rise in water level should not be associated with the amount of oxygen utilised in burning of the candle.

Nitrogen

In Activity 3 did you observe that a major part of air is still present in the glass bottle even after the candle blew out? This indicates the presence of some component in the air, which does not support burning. The major part of air (which does not support burning candle) is nitrogen. It takes up nearly four-fifth of the space that air fills.



Carbon dioxide

In a closed room, if there is some material that is burning, you may have felt suffocation. This is due to excess of carbon dioxide that may be accumulating in the room, as the burning continues. Carbon dioxide makes up a small component of the air around us. Plants and animals consume oxygen for respiration and produce carbon dioxide. Plant and animal matter on burning, also consumes oxygen and produces mainly carbon dioxide and a few other gases.

Dust and smoke

The burning of fuel also produces smoke. Smoke contains a few gases and fine dust particles and is often harmful. That is why you see long chimneys in factories. This takes the harmful smoke and gases away from our noses, but, brings it closer to the birds flying up in the sky! Dust particles are always present in air.

Activity 4

Find a sunny room in your school/home. Close all the doors and windows with curtains pulled down to make the room dark. Now,

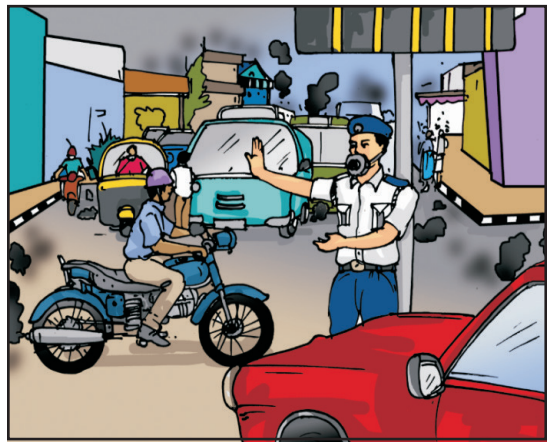

Fig 15.8 Policemen regulating traffic at a crowded crossing often wear a mask



Fig 15.7 Observing presence of dust in air with sunlight

open the door or a window facing the sun, just a little, in such a way that it allows sunlight to enter the room only through a slit. Look carefully at the incoming beam of sunlight.

Do you see some tiny shining particles moving in the beam of sunlight (Fig. 15.7)? What are these particles?

During cold winters you might have observed similar beam of sunlight filter through the trees in which dust particles appear to dance merrily around!

This shows that air also contains dust particles. The presence of dust particles in air varies from time to time, and from place to place.

We inhale air when we breathe through our nostrils. Fine hair and mucus are present inside the nose to prevent dust particles from getting into the respiratory system.

Do you recall being scolded by your parents when you breathe through your mouth? If you do that, harmful dust particles may enter your body.

We may conclude, then, that air contains some gases, water vapour and dust particles. The gases in air are mainly nitrogen, oxygen, small amount of carbon dioxide, and many other gases.



However, there may be some variations in the composition of air from place to place. We see that air contains mostly nitrogen and oxygen. In fact, these two gases together make up 99% of the air. The remaining 1% is constituted by carbon dioxide and a few other gases, water vapour and dust particles.

15.3 HOW DOES OXYGEN BECOME AVAILABLE TO ANIMALS AND PLANTS LIVING IN WATER AND SOIL?

Activity 5

Take some water in a glass vessel or beaker. Heat it slowly on a tripod stand. Well before the water begins to boil, look carefully at the inner surface of the vessel. Do you see tiny bubbles on the inside (Fig. 15.9).

These bubbles come from the air dissolved in water. When you heat the water, to begin with, the air dissolved in it escapes. As you continue heating, the water itself turns into vapour and finally begins to boil. We learnt in Chapters 8 and 9, that the animals living in water use the dissolved oxygen in water.

The organisms that live in soil also need oxygen to respire, isn't it? How do they get the air they need, for respiration?



Fig 15.9 Water contains air

Activity 6

Take a lump of dry soil in a beaker or a glass. Add water to it and note what happens (Fig. 15.10). Do you see bubbles coming out from soil? These bubbles indicate the presence of air in the soil.



Fig 15.10 Soil has air in it

When the water is poured on the lump of soil, it displaces the air which is seen in the form of bubbles. The organisms that live inside the soil and the plant roots respire in this air. A lot of burrows and holes are formed in deep soil by the animals living in the soil. These burrows also make spaces available for air to move in and out of the soil. However, when it rains heavily, water fills up all the spaces occupied by the air in the soil. In this situation, animals living in the soil have to come out for respiration.

Could this be the reason why earthworms come out of the soil, only during heavy rains?

Have you ever wondered why all the oxygen of atmosphere does not get used up though a large number of organisms are consuming it? Who is refilling the oxygen in the atmosphere?



15.4 HOW IS THE OXYGEN IN THE ATMOSPHERE REPLACED?

In Chapter 7, we read about photosynthesis. In this process, plants make their own food and oxygen is produced along with it. Plants also consume oxygen for respiration, but they produce more of it than they consume. That is why we say plants produce oxygen.

It is obvious that animals cannot live without plants. The balance of oxygen and carbon dioxide in the atmosphere is maintained through respiration in plants and animals and by the photosynthesis in plants. This shows the interdependence of plants and animals.

We can now appreciate how important air is for life on earth. Are there any other uses of air? Have you heard about a windmill? Look at Fig. 15.11.



Fig 15.11 A Windmill

The wind makes the windmill rotate. The windmill is used to draw water from tubewells and to run flour mills. Windmills are also used to generate electricity. Air helps in the movements of sailing yachts, gliders, parachutes and aeroplanes. Birds, bats and insects can fly due to the presence of air. Air also helps in the dispersal of seeds and pollen of flowers of several plants. Air plays an important role in water cycle.



What You have Learnt

- Air is found everywhere. We cannot see air, but we can feel it.
- Air in motion is called wind.
- Air occupies space.
- Air is present in water and soil.
- Air is a mixture of nitrogen, oxygen, carbon dioxide, water vapour and a few other gases. Some dust particles may also be present in it.
- Oxygen supports burning and is necessary for living organisms.
- The envelope of air that surrounds the earth is known as atmosphere.
- Atmosphere is essential for life on earth.
- Aquatic animals use dissolved air in water for respiration.
- Plants and animals depend on each other for exchange of oxygen and carbon dioxide from air.



Exercises

1. What is the composition of air?
2. Which gas in the atmosphere is essential for respiration?
3. How will you prove that air supports burning?
4. How will you show that air is dissolved in water?
5. Why does a lump of cotton wool shrink in water?
6. The layer of air around the earth is known as _____.
7. The component of air used by green plants to make their food, is _____.
8. List five activities that are possible due to the presence of air.
9. How do plants and animals help each other in the exchange of gases in the atmosphere?
10. Plants need _____ to make their food.
11. The moving air is called _____.

SUGGESTED PROJECTS AND ACTIVITIES

1. On a clear glass window facing towards an open area, fix a small rectangular strip of paper. Remove the strip after a few days. Do you notice a difference between the rectangular section that was left covered with paper and the rest of the glass window? By repeating this exercise every month, you can have an idea about the amount of dust present in air around you at different times of the year.
2. Observe the leaves of trees, shrubs or bushes planted by the roadside. Note whether their leaves have some dust or soot deposited over them. Take similar observations with the leaves of trees in the school compound or in a garden. Is there any difference in deposition of soot on leaves of trees near the roadside? What could be the possible reasons for this difference? Take a map of your city or town and try to identify regions in the map where you have noticed very thick layer of soot on the plants by the roadside. Compare with results obtained by other classmates and mark these areas on the map. Perhaps the results from all the students could be summarised and reported in newspapers.





Garbage in, Garbage out

Keywords : Hazardous, Trash, Landfill, Compost, Red-worm, Disposal

16.1 WASTE

When something is unwanted or no longer serves a purpose, it is termed as waste. Waste comes from us and through our activities. Waste may be solid, liquid or gaseous depending on the state of matter. What we throw out from our homes, schools, shops and offices is solid waste (garbage-rubbish trash). It can be a pack of purchased articles, wrapping material or even plastic containers. This is called Municipal solid waste or MSW.

What if the trash is not removed from our homes and surroundings? It will definitely harm us in a very bad manner. Now it is time for us to look into the problem.

The chapter will enable us to see if we can clean our surroundings and how? Let's us see:

The various kinds of waste are:

Wet Waste; Kitchen waste such as vegetables peels, remains of fruits and vegetables left over/ spoiled food, leaves , cut gram etc.

Dry waste: Scrapes of paper, plastic, metal glass, rubber, leather, bags etc.

Hazardous wastes: used battery, expired medicines, paints, insecticides etc.

Biomedical wastes: Soiled bandages, used needles, syringes, soiled instruments.

Construction wastes: Waste resulting from construction, repair or demolition of buildings, bricks, concrete, metal scrap etc. Since our concern is Our Surrounding. Let us take solid waste into consideration.

Activities Establishments	Wastes generated
1. Domestic	Vegetables and fruit peels, leftover food, paper, Plastic and other packaging material, glass, garden collections like dried leaves cut grass, medicines, containers.
2. Locally School:	Wastes swept from School in the from of paper. left over food, containers etc.

16.2 WHEN WASTE IS A-PROBLEM:

Wastes of all kinds are a problem when quantity and concentration are too much, it becomes a hazard. Waste when not managed properly it can become harmful to human health and can cause damage to the environment. This can happen when the waste - is not disposed properly.



Waste and Health

Waste generation leads to air, soil, surface and ground water pollution

-Solid waste takes up open space.

-Solid waste dumps attract flies, mice, etc which are health hazard. They cause disease.

Waste and Disposal

With industrialization and increasing consumers, the quantity of garbage has increased, and the nature of the garbage too has changed. Your School, your home present a picture in this regard.

Things to do in this direction

Primary collection and storage.

Why Waste Management;

Our convenience oriented life style not only consumes a great deal of natural resources but also wastes them, many resources are converted to products with very soft life spans. For example. Using petroleum to produce plastic materials and package materials to be discarded after only one use wastes. Valuable resources and adds to the solid waste.

Managing of such wastes is dire need of the time so that these do not cause environmental and health problems. But a simple solution is not handy. For it a variety of waste management practices are to be considered which are

Reduction at source

Reuse of products

Recycling of waste products;

Reducing, reusing, and recycling decrease both the demands on natural sources, as well as the rate at which they are consumed. Fewer resources are used, limited supplies are conserved and regeneration of renewable resources can occur.

Accordingly less waste is generated, less amount to be buried (decreasing water pollution), less trash to be burnt (decreasing air pollution). By reducing, reusing and recycling, we can help to conserve the earth and the life it supports for many generations to come.

Recycling of Paper

Recycling refers to the process by which material once used and discarded are used again to substitute for original material.

Most household/school trash/garbage is recyclable. Paper, plastic, metal can be reused . Recycling has several benefits-it reduces the amount of waste, amount off energy needed to make new products, reduces pollution.

Activity 1

Ask students to collect waste paper from old notebooks, used, unwanted stationary at home, old newspapers to prepare recycled paper. Encourage them to collect the waste paper from all possible places.



Do You Know

The average family dustbin contains 10% glass, 9% metals, 3% textiles, 4% plastics, 30% vegetable waste dust and other materials, 60% of which could be recycled.

Materials needed:

- To be contributed by the students.
1. Large plastic Buckets/bowls/basins.
 2. Wooden spoon.
 3. A net-sieve.

Do You Know

For every tonn of waste paper collected and recycled, two trees are

Making the pulp:

Ask the students to remove any kind of pins, staples in the paper and tear the paper into small pieces. Place these pieces in the plastic container. Pour warm waster in the container such the water stands about 1cm above the paper layer. Allow it to soak for 3-4 days. Stir the mixture every day to help break the paper fibres down. See that the shredded paper suspended in the water looks like a soup. The soup is ready for use to make paper. Corn starch may be added to the mixture for smoothness and stability.

Making of paper

Now, spread the wet paste on the wire mesh fixed to the frame. Pat it gently to make the thickness of layer of the paste as uniform as possible. Wait till water drains off. If required spread an old cloth or a sheet of newspaper on the paste to let it soak up the extra water.

Now, carefully remove the layer of paste from the frame, spread it on a sheet of newspaper in the sun. Keep the corners of the newspaper sheet pressed by putting some weights so that these do not curl up.

You can add food colour, pieces of dry leaves or flower petals or pieces of coloured paper in the paste before spreading it. It would help you to get a recycled paper with beautiful patterns on it.

Can we recycle everything, just as we recycle paper?

16.3 DEALING WITH GARBAGE

Safai karamcharis collect the garbage in trucks and take it to a low lying open area, called a landfill (Fig. 16.1).

There the part of the garbage that can be reused is separated out from the one that cannot be used as such. Thus, the garbage has both useful and non-useful



Fig 16.1 A land fill



components. The non-useful component is separated out. It is then spread over the landfill and then covered with a layer of soil. Once the landfill is completely full, it is usually converted into a park or a play ground. For the next 20 years or so, no building is constructed on it. To deal with some of the useful components of garbage, compost making areas are developed near the landfill. What is compost? Let us learn about it, from the following activity.

Activity 2

Collect the garbage from your house before it is thrown into the dustbin. Separate it into two groups, so that they have:

Group 1: Garbage from the kitchen — like fruit and vegetable peels, egg shells, waste food, tea leaves. Include newspapers, dry leaves and paper bags in this group.

Group 2: Pieces of cloth, polythene bags, broken glass, aluminium wrappers, nails, old shoes and broken toys.

Now divide the contents of each group into two separate heaps. Label them as A, B, C and D. Put one heap from Group 1 and one heap from Group 2 into two separate plastic bags. Tie the mouth of these two bags tightly. Put all the four heaps in separate pits and cover them with soil (Fig. 16.2). You can also use four pots to bury these garbage heaps.



Fig 16.2 Putting garbage heaps in pits

Remove the soil after four days and observe the changes in the garbage. A black colour and no foul smell indicates that rotting of garbage is complete. Put the heaps again in the pits and cover with the soil. Observe again after every two days and note your observations as suggested. Did the garbage?

- (i) rot completely and not smell?
- (ii) rot only partially?
- (iii) rot almost completely, but still smells bad?
- (iv) not change at all?

Garbage in which heap was seen to rot and which did not?

Enter options (i), (ii), (iii) or (iv) in the columns of Table 16.1 based on your observations. If you make any other observations, do not forget to write all these down in your notebook. Do not remove and burn the garbage that did not rot.



Table 16.1 What has happened to the garbage heaps?

Garbage heap	After 4 days	After 6 days	After 2 weeks	After 4 weeks
A				
B				
C				
D				

If the garbage was found to rot completely and did not smell, mix it in the soil where you sow your favourite plants. This would provide nutrients to the plants.

You must have observed from this activity that some things in the garbage rot. They form manure which is used for the plants. The rotting and conversion of some materials into manure is called ‘composting’.

In some cities and towns municipalities provide separate dustbins for collecting two kinds of garbage. Usually one is coloured blue and the other green. The blue bin is for materials that can be used again — such as plastics, metals and glass. Did you notice that these are the materials that do not rot in the garbage heaps?

The green bins are for collecting kitchen and other plant or animal wastes. You may have noticed that this type of wastes rot completely when buried in the soil. Do you see why it is necessary for us to separate waste into two groups as we did in Activity 2, before we throw it?



Fig 16.3 Burning of leaves produce harmful gases

Have you noticed garbage heaps of dried leaves on the roadside? Most of the time these are burnt (Fig. 16.3). Farmers too often burn the husk, dried leaves and part of crop plants in their fields after harvesting. Burning of these, produces smoke and gases that are harmful to our health. We should try to stop such practices. These wastes could be converted into useful compost.

16.4 VERMICOMPOSTING

We can be friends of plants by supplying them with compost. We will also be very good friends to ourselves by making compost.

Talking of friends, do you know that earthworms are called farmer’s friend? Let us find out how a type of earthworm called redworm is used for composting. This method of preparing



compost with the help of redworms is called vermicomposting. We can try to make manure by vermicomposting at school.

Activity 3

Let us dig a pit (about 30 cm deep) or keep a wooden box at a place, which is neither too hot nor too cold. What about a place which does not get direct sunlight? Let us now make a comfortable home for our redworms in the pit or the box.

Spread a net or chicken mesh at the bottom of the pit or the box. You can also spread 1 or 2 cm thick layer of sand as an alternative. Now, spread some vegetable wastes including peels of fruits over this layer of sand.

One can also use green leaves, pieces of dried stalks of plants, husk or pieces of newspaper or cardboard to spread over the layer of sand. However, shiny or plastic coated paper should not be used for this purpose. Dried animal dung could also be used as a spread over sand or wire mesh.



Fig 16.5 Food for redworms

Your redworms need food. You can give them vegetable and fruit wastes, coffee and tea remains and weeds from the fields or garden (Fig. 16.5). It might be a good idea to bury this food about 2-3 cm inside the pit. Do not use wastes that may contain salt, pickles, oil, vinegar, meat and milk preparations as food for your redworms. If you put these things in the pit, disease-causing small organisms start growing in the pit. Once in a few days, gently mix and move the top layers of your pit.

Redworms do not have teeth. They have a structure called 'gizzard', which helps them in grinding their food. Powdered egg shells or sea shells could be mixed with the wastes. This would help redworms in grinding their food. A redworm can eat food equal to its own weight, in a day.



Fig 16.4 Redworms

Sprinkle some water to make this layer wet. Take care not to use excess of water. Do not press the layer of waste. Keep this layer loose so that it has sufficient air and moisture.

Now, your pit is ready to welcome the redworms. Buy some redworms and put them in your pit (Fig. 16.4). Cover them loosely with a gunny bag or an old sheet of cloth or a layer of grass.



Fig 16.6 Vermicomposting



Redworms do not survive in very hot or very cold surroundings. They also need moisture around them. If you take good care of your worms, in a month's time their number will double.

Observe the contents of the pit carefully after 3-4 weeks. Do you now see loose, soil-like material in the pit? Your vermicompost is ready (Fig. 16.6).

Put some wastes as food in one corner of the pit. Most of the worms will shift towards this part of the pit, vacating the other part. Remove the compost from the vacated part and dry it in the sun for a few hours. Your vermicompost is ready for use!

The part left in the pit has most of the worms in it. You can use these for preparing more compost or share them with another user.

Use this excellent vermicompost in your pots, gardens or fields. Is this not like getting the 'best out of waste'? Those of you who have agricultural fields can try vermicomposting in large pits. You can save a lot of money that is spent on buying expensive chemical fertilizers and manure from the market.

16.5 THINK AND THROW

How much of garbage do you think, is thrown out by each house everyday? You can make an estimate by using a bucket as a measure. Use a 5-10 litre bucket to collect the garbage from your home for a few days. In how many days does the bucket become full? You know the number of members in your family. If you find out the population of your city or town, can you now estimate the number of buckets of garbage that may be generated in a day in your city or town? We are generating mountains of garbage everyday, isn't it (Fig. 16.7)?



Fig 16.7 Neighbourhood garbage dump

16.6 PLASTICS – BOON OR A CURSE?

Some kind of plastics can be recycled, but, not all of them. Did you notice that polythene bags and some plastics did not rot in Activity 1? You might now easily understand why polythene bags create a big problem in garbage disposal.

It may be a little difficult to imagine our life without plastics. Shall we list a few things we use that are made of plastics? Toys, shoes, bags, pens, combs, tooth brushes, buckets, bottles, and water pipes — the list is very long. Can you name a few parts of a bus, car, radio, television, refrigerator and a scooter that are made of plastics?

The use of plastics in itself might not create so much of a problem. Problems arise when we use plastics excessively and are ignorant about ways of disposing their waste. This is what is happening all around us! We might even be acting irresponsibly, knowing well about its harmful effects.



We often use plastic bags to store cooked food items. Sometimes these bags may not be suitable for keeping eatables. Consuming food packed in such plastic bags could be harmful to our health. Many a time shopkeepers use plastic bags that have been used earlier for some other purpose. Sometimes bags collected by rag pickers are also used after washing them. Use of such recycled plastic bags to keep food items could be harmful for our health. For storing eatables we must insist on use of plastic bags that are approved for such a use.

All kind of plastics give out harmful gases, upon heating or burning. These gases may cause many health problems, including cancer, in humans. The government has also laid down guidelines for recycling of plastics.

You must have noticed that people often fill garbage in plastic bags and then throw it away. When stray animals look for food in these bags, they end up swallowing these. Sometimes, they die due to this.

The plastic bags thrown away carelessly on roads and other places get into drains and the sewer system. As a result, drains get choked and the water spills on the roads. During heavy rains, it might even create a flood like situation. There is a lot of harm that too much use of plastics can do!

What can we do to minimise over use of plastics and deal with garbage?

1. We make a minimum use of plastic bags. We re-use the bags whenever it is possible to do so without any adverse affects.
2. We insist shopkeepers use paper bags. We carry a cloth or a jute bag when we go out for shopping.
3. We do not use plastic bags to store eatables.
4. We do not throw plastic bags here and there, after use.
5. We never burn plastic bags and other plastic items.
6. We do not put garbage in plastic bags and throw it away.
7. We use vermicomposting at home and deal with our kitchen waste usefully.
8. We recycle paper.
9. We use both sides of the paper to write. We use a slate for rough work. We use blank sheets of paper left in our notebooks for rough work.
10. We make our family, friends and others to follow proper practices for disposing different kinds of wastes.

The most important point to know and think about is that — more garbage we generate, more difficult it will be to get rid of it.



What You have Learnt

- Landfill is an area where the garbage collected from a city or town is dumped. The area is later converted into a park.
- Converting plant and animal waste including that from kitchen, into manure, is called composting.
- The method of making compost from kitchen garbage using redworms is called vermicomposting.
- Paper can be recycled to get useful products.
- Plastics cannot be converted into less harmful substances by the process of composting.
- We need to generate less waste and find ways of dealing with the increasing amount of garbage in our surroundings.



Exercises

1. a. Which kind of garbage is not converted into compost by the redworms?
b. Have you seen any other organism besides redworms, in your pit? If yes, try to find out their names. Draw pictures of these.
2. Discuss:
 - a. Is garbage disposal the responsibility only of the government?
 - b. Is it possible to reduce the problems relating to disposal of garbage?
3. a. What do you do with the left over food at home?
b. If you and your friends are given the choice of eating in a plastic plate or a banana leaf platter at a party, which one would you prefer and why?
4. a. Collect pieces of different kinds of paper. Find out which of these can be recycled.
b. With the help of a lens look at the pieces of paper you collected for the above question. Do you see any difference in the material of recycled paper and a new sheet of paper?



5. a. Collect different kinds of packaging material. What was the purpose for which each one was used? Discuss in groups.
b. Give an example in which packaging could have been reduced?
c. Write a story on how packaging increases the amount of garbage.
6. Do you think it is better to use compost instead of chemical fertilisers? Why?

ACTIVITIES FOR DEALING WITH GARBAGE

1. Collect old and discarded objects and material like glass bottles, plastic bottles, coconut husk, wool, bed sheets, greeting cards and any other thing. Can you make something useful out of these, instead of throwing them? Try.
2. Prepare a detailed project report on compost making activity you did in school.

MATTER OF CONCERN!

1. In autumn lots of leaves are burnt in cities and towns. Some of the gases produced by burning leaves are similar to the gases released by the vehicles moving on the roads.
2. Instead of burning, if we make compost from these leaves, we can reduce the use of chemical fertilizers.
3. The green areas which should have fresh air, actually become full of harmful gases due to burning of leaves.
4. If you find any one is burning the leaves bring it to notice of municipal authorities or write to newspapers about it.
5. Generate social pressure against burning of leaves. Ensure that fallen leaves are not burnt but used for making compost.
6. Write to the 'Tree Authority' of your city or state to declare burning of leaves as an offence.

